





tam düşündüğünüz gibi *just as you thought*

[www.smsarayli.com.tr](http://www.smsarayli.com.tr)



**ENDÜSTRİYEL MERDİVENDE  
EN ÜST BASAMAKTAYIZ**

We are **the top** step of the  
industrial type ladder



**Çevre Dostu** fabrikamız ile yıllık **5.000.000 kWh** elektrik üreterek **2445 Ton/CO<sub>2</sub>** salınımı önlüyoruz.

Thanks to our "**Environmentally Friendly**" factory, we produce **5.000.000 kWh** of electricity annually and prevent **2445 tons/CO<sub>2</sub>** emissions.

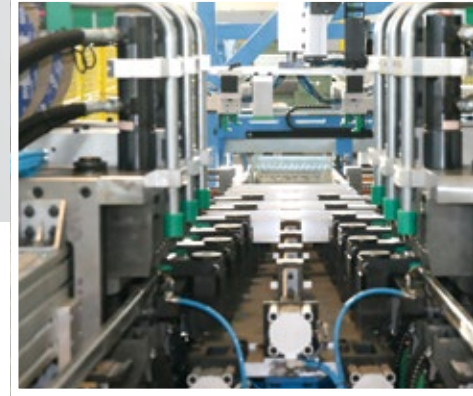

Konya' dan dünyaya yayılan bir marka, SARAYLI. Çeyrek asırlık üretim hayatına, birçok başarıyı ve müşteri memnuniyetini sığdıran sektörünün en önemli markalarından biri... Global seviyede bilgi ve teknoloji kullanımına inanan, işbirliği ve güven temelinde istikrarla atılımlar yapmayı kendine ilke edinen SARAYLI bu temel üzerinde büyümeyi ve gelişimini sürdürüyor.

Sürekli gelişim, değişmez kalite yaklaşımını ve koşulsuz müşteri memnuniyeti ilkelerine, üretim ile birlikte satış sonrasında da taviz vermeyen SARAYLI, projeksiyonu'nu hep bu doğrultuda gerçekleştirmektedir.

Konya Organize Sanayi Bölgesinde toplam 70.000 m<sup>2</sup> açık alanda kurulu, 32.000 m<sup>2</sup>lik kapalı alana sahip tesislerinde faaliyetini sürdürmektedir. Tam otomatik üretim hatlarında, ütü masası, kurutmalı ve merdiven üretimini uluslararası normlara göre gerçekleştirmektedir. Ulusal ve uluslararası birçok kalite belgesine sahip olan SARAYLI, ürünlerinin tasarımı, ergonomisi ve dayanıklılığı ile müşterilerinin beklentilerini en üst düzeyde karşılamaktadır.

SARAYLI ve LADY markalarını, ulusal ve uluslararası pazarda yürütmüş olduğu pazarlama ve iletişim faaliyetleri ile çok geniş kitlelere ulaştırmıştır. Yurt içine son derece geniş bir ürün yelpazesi sunan SARAYLI, 30'un üzerinde ülkeye ihracat yaparak ülke ekonomisine katkıda bulunmaktadır.

# HAKKIMIZDA

## ABOUT US



*Sarayli in KONYA is one of the most expanding brands all around the world. It has also been on the top in terms of production and customers' satisfaction for over 25 years. The principle that lies behind the success of our company is the eminent use of information and technology on a global level and the stable progress that is based on cooperation and trust.*

*Sarayli is always conducting its projection according to the principles of continues development, constant quality approach and unconditional customer satisfaction both during the production and aftersales.*

*It is operating its activities in 32.000 m<sup>2</sup> facility founded on totally 70.000 m<sup>2</sup> open area with Konya Organized Industrial Zone. Sarayli produces ironing boards, laundry frames and ladders in its full machinery lines according to the international standards. Moreover, The brand Sarayli has been issued the widest EN1004 certificate plus many national and international certificates as a result its products' design, ergonomoy and endurance throughout the years.*

*Sarayli and Lady gained their fame and wide-recognition in the national and international markets through an expanding range of marketing and communication with the enormous database of customers all around the world. Sarayli, on the other hand, contributes to the state economy by exporting its very large products group to more than 46 different countries.*

# KALİTE BELGELERİMİZ

## QUALITY CERTIFICATES

**CERTIFICATE**  
No. Z1 053076 0005 Rev. 00

**Holder of Certificate:** Konya Saraylı Madeni Eşya İmalat Paz.  
Şah. Tic. Ltd. Şti  
7234000 Akademi Cad. No: 13  
Konya Organize Sanayi Bölgesi  
42020 Suluçka / Konya  
TÜRKİYE

**Certification Mark:**

**Product:** Multi-purpose ladders  
(Combination ladders)

The product was tested on a voluntary basis and complies with the essential requirements. The certification mark shown above can be affixed to the product. It is not permitted to alter the certification mark in any way. In addition, the certification holder must not transfer the certificate to third parties. This certificate is valid until the stated date, unless it is suspended or annulled. Applicable requirements of the issuing and certification regulations of TÜV SÜD Group have to be completed. For details see: www.tuv.sud.com.tr

**Test report no.:** MED170702002078  
**Valid until:** 2024-07-05  
**Date:** 2021-08-03  
(GIANPAOLO MENGA)

Page 1 of 2  
TUV SÜD Product Service Center - Certification Body - Rosenstraße 66 - 85389 Munich - Germany

**CERTIFICATE**  
No. Z1 053076 0006 Rev. 00

**Holder of Certificate:** Konya Saraylı Madeni Eşya İmalat Paz.  
Şah. Tic. Ltd. Şti  
7234000 Akademi Cad. No: 13  
Konya Organize Sanayi Bölgesi  
42020 Suluçka / Konya  
TÜRKİYE

**Certification Mark:**

**Product:** Ladders  
(Extending and Leaning rungs ladders)

The product was tested on a voluntary basis and complies with the essential requirements. The certification mark shown above can be affixed to the product. It is not permitted to alter the certification mark in any way. In addition, the certification holder must not transfer the certificate to third parties. This certificate is valid until the stated date, unless it is suspended or annulled. Applicable requirements of the issuing and certification regulations of TÜV SÜD Group have to be completed. For details see: www.tuv.sud.com.tr

**Test report no.:** MED170702002078  
**Valid until:** 2024-07-05  
**Date:** 2021-08-03  
(GIANPAOLO MENGA)

Page 1 of 2  
TUV SÜD Product Service Center - Certification Body - Rosenstraße 66 - 85389 Munich - Germany

**CERTIFICATE**  
No. Z1 053076 0007 Rev. 00

**Holder of Certificate:** Konya Saraylı Madeni Eşya İmalat Paz.  
Şah. Tic. Ltd. Şti  
7234000 Akademi Cad. No: 13  
Konya Organize Sanayi Bölgesi  
42020 Suluçka / Konya  
TÜRKİYE

**Certification Mark:**

**Product:** Standing step ladders

The product was tested on a voluntary basis and complies with the essential requirements. The certification mark shown above can be affixed to the product. It is not permitted to alter the certification mark in any way. In addition, the certification holder must not transfer the certificate to third parties. This certificate is valid until the stated date, unless it is suspended or annulled. Applicable requirements of the issuing and certification regulations of TÜV SÜD Group have to be completed. For details see: www.tuv.sud.com.tr

**Test report no.:** MED170702002078  
**Valid until:** 2024-07-05  
**Date:** 2021-08-03  
(GIANPAOLO MENGA)

Page 1 of 2  
TUV SÜD Product Service Center - Certification Body - Rosenstraße 66 - 85389 Munich - Germany

**TUV NORD**  
ATTESTATION OF CONFORMITY  
CERTIFICATE

**Client Name:** Konya Saraylı Madeni Eşya İmalat Paz. Şah. Tic. Ltd. Şti  
**Client Address:** Konya Organize Sanayi Bölgesi, Akademi Cad. No: 13, 42020 Suluçka / Konya, Türkiye

**Product:** Multi-purpose ladders (Combination ladders)

**Standard:** EN 15762:2016, EN 15763:2016

**Issue Date:** 2021-08-03  
**Valid Until:** 2024-07-05

**Signature:** (GIANPAOLO MENGA)

**ASCERT**  
UYGUNLUK ONAYI

**Marka Adı:** Konya Saraylı Madeni Eşya İmalat Paz. Şah. Tic. Ltd. Şti  
**Marka No:** 1308841 - Tescim

**Standartlar:** EN 15762:2016, EN 15763:2016

**Test Raporu No:** MED170702002078  
**Geçerlilik Tarihi:** 2024-07-05  
**Yayın Tarihi:** 2021-08-03

**CE**

**ASCERT**  
UYGUNLUK ONAYI

**Marka Adı:** Konya Saraylı Madeni Eşya İmalat Paz. Şah. Tic. Ltd. Şti  
**Marka No:** 1308841 - Tescim

**Standartlar:** EN 15762:2016, EN 15763:2016

**Test Raporu No:** MED170702002078  
**Geçerlilik Tarihi:** 2024-07-05  
**Yayın Tarihi:** 2021-08-03

**CE**

**ASCERT**  
UYGUNLUK ONAYI

**Marka Adı:** Konya Saraylı Madeni Eşya İmalat Paz. Şah. Tic. Ltd. Şti  
**Marka No:** 1308841 - Tescim

**Standartlar:** EN 15762:2016, EN 15763:2016

**Test Raporu No:** MED170702002078  
**Geçerlilik Tarihi:** 2024-07-05  
**Yayın Tarihi:** 2021-08-03

**CE**

**TÜRK PATENT VE TİCARİ MARKA ENSTİTÜSÜ**  
MARKA YENİLEME BELGESİ  
Marka No: 1308841 - Tescim

**Marka Sahibi:** Konya Saraylı Madeni Eşya İmalat Paz. Şah. Tic. Ltd. Şti  
**Marka No:** 1308841 - Tescim

**Yayın Tarihi:** 2021-08-03  
**Geçerlilik Tarihi:** 2024-07-05

**TÜRK PATENT**

**TÜRK STANDARLARI ENSTİTÜSÜ**  
TÜRKİŞ STANDARLARINA UYUMLUK BELGESİ  
CERTIFICATE OF CONFORMITY TO TURKISH STANDARDS

**Marka Adı:** Konya Saraylı Madeni Eşya İmalat Paz. Şah. Tic. Ltd. Şti  
**Marka No:** 1308841 - Tescim

**Standartlar:** EN 15762:2016, EN 15763:2016

**Test Raporu No:** MED170702002078  
**Geçerlilik Tarihi:** 2024-07-05  
**Yayın Tarihi:** 2021-08-03

**TÜRK STANDARLARI ENSTİTÜSÜ**  
TÜRKİŞ STANDARLARINA UYUMLUK BELGESİ  
CERTIFICATE OF CONFORMITY TO TURKISH STANDARDS

**Marka Adı:** Konya Saraylı Madeni Eşya İmalat Paz. Şah. Tic. Ltd. Şti  
**Marka No:** 1308841 - Tescim

**Standartlar:** EN 15762:2016, EN 15763:2016

**Test Raporu No:** MED170702002078  
**Geçerlilik Tarihi:** 2024-07-05  
**Yayın Tarihi:** 2021-08-03

**TÜRK STANDARLARI ENSTİTÜSÜ**  
TÜRKİŞ STANDARLARINA UYUMLUK BELGESİ  
CERTIFICATE OF CONFORMITY TO TURKISH STANDARDS

**Marka Adı:** Konya Saraylı Madeni Eşya İmalat Paz. Şah. Tic. Ltd. Şti  
**Marka No:** 1308841 - Tescim

**Standartlar:** EN 15762:2016, EN 15763:2016

**Test Raporu No:** MED170702002078  
**Geçerlilik Tarihi:** 2024-07-05  
**Yayın Tarihi:** 2021-08-03

**TÜRK PATENT VE TİCARİ MARKA ENSTİTÜSÜ**  
MARKA TESCHİ BELGESİ  
Marka No: 1308841 - Tescim

**Marka Sahibi:** Konya Saraylı Madeni Eşya İmalat Paz. Şah. Tic. Ltd. Şti  
**Marka No:** 1308841 - Tescim

**Yayın Tarihi:** 2021-08-03  
**Geçerlilik Tarihi:** 2024-07-05

**TÜRK PATENT VE TİCARİ MARKA ENSTİTÜSÜ**

# ENDÜSTRİYEL MERDİVEN GRUBU

**INDUSTRIAL**  
LADDER  
GROUP



tam düşündüğünüz gibi | just as you thought

7307 | 7315

Endüstriyel Merdiven Grubu • Industrial Ladder Group | [www.smsarayli.com.tr](http://www.smsarayli.com.tr)

3 KADEMELİ ALÜMİNYUM ENDÜSTRİYEL MERDİVEN  
3 SECTION ALUMINIUM INDUSTRIAL LADDER

HER  
**BASAMAKTA**  
PROFESYONEL



### 3 KADEMELİ ALÜMİNYUM ENDÜSTRİYEL MERDİVEN

#### 3 SECTION ALUMINIUM INDUSTRIAL LADDER



Certificate  
**EN 131**  
Norm

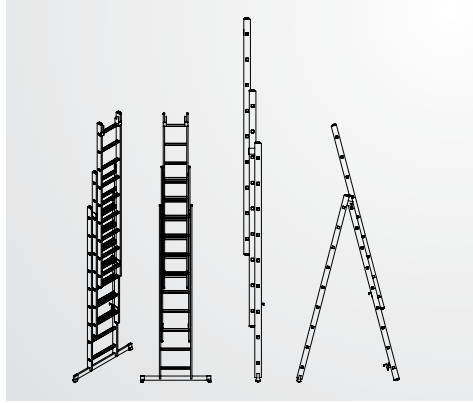
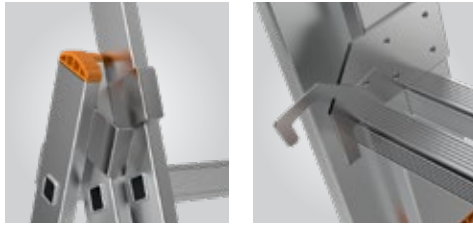

### 3 KADEMELİ

#### ALÜMİNYUM ENDÜSTRİYEL MERDİVEN

- Özel alaşımlı alüminyum merdiven
- 3 kademeli kullanım
- Kolay açılıp kapanabilme
- Tek parçalı kullanım
- Kullanıma hazır tek şıklı ambalaj
- Kaymayı önleyen özel tasarımı basamaklar
- Endüstriyel amaçlı kullanım
- Uzun ömürlü Paslanmaz maksimum mukavemet
- Basamakların maksimum mukavemetini ve dengesini sağlamak için profil bağlantı noktasında çift taraflı şişirme

### 3 SECTION

#### ALUMINIUM INDUSTRIAL LADDER

- Special alloyed aluminum ladder
- 3 Sectional usage
- Can be used as single section
- Pratical folding away
- Ready to use stylish single pack
- Exclusively designed steps which prevents slipping
- Can be used for Industrial Purpose
- Durable,rustproof, maximum strenght
- Double sided inflating at profile point to provide the maximum strenght and balance of the steps



Barkod	Kod	Basamak Sayısı	Profil	1 Kademe Yükseklik	2 Kademe Yükseklik	3 Kademe Yükseklik	2 Kademe A Tipi Yükseklik	3 Kademe A Tipi Yükseklik	Dıştan Dışa Genişlik	Ambalajlı Ölçüleri	Ağırlık	1 Adet m <sup>3</sup>
Barcode	Code	Number of Steps	Profile	1 Section Height	2 Section Height	3 Section Height	Section 2 Type A Height	Section 3 Type A Height	Out-To-Out Width	Packed Size	Weight	1 Pcs. m <sup>3</sup>
										a b c		
8695849009776	7307	3x7	60x20	1930	3010	4090	1815	2880	355/410/465	470 170 1980	12,42	0,17
8695849009752	7309	3x9	70x20	2470	4090	5710	2325	3850	355/410/465	470 185 2520	16,00	0,23
8695849009738	7311	3x11	70x20	3010	5170	7330	2830	4860	355/410/465	470 185 3060	18,94	0,28
8695849009714	7313	3x13	80x20	3550	6250	8950	3330	5870	355/410/465	470 200 3600	25,84	0,36
8695849009691	7315	3x15	80x25	4090	7330	10570	3850	6890	360/425/485	490 200 4140	32,17	0,41

## 2 KADEMELİ A TİPİ ve SÜRGÜLÜ ENDÜSTRİYEL MERDİVEN 2 SECTION INDUSTRIAL LADDER (TYPE A)



Certificate  
EN 131  
Norm



## 2 KADEMELİ A TİPİ SÜRGÜLÜ ALÜMİNYUM ENDÜSTRİYEL MERDİVEN

- Özel alaşımli alüminyum merdiven
- 2 kademeli kullanım
- Kolay açılıp kapanabilme
- Tek parçalı kullanım
- Kullanıma hazır tek şıklı ambalaj
- Kaymayı önleyen özel tasarımlı basamaklar
- Endüstriyel amaçlı kullanım
- Uzun ömürlü Paslanmaz maksimum mukavemet
- Basamakların maksimum mukavemetini ve dengesini sağlamak için profil bağlantı noktasında çift taraflı şişirme

## 2 SECTION INDUSTRIAL LADDER TYPE A

- Special alloyed aluminum ladder
- 2 Sectional usage
- Can be used as single section
- Pratical folding away
- Ready to use stylish single pack
- Exclusively designed steps which prevents slipping
- Can be used for Industrial Purpose
- Durable, rustproof, maximum strenght
- Double sided inflating at profile point to provide the maximum strenght and balance of the steps

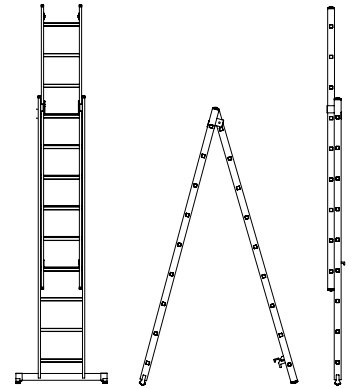

Barkod Barcode	Kod Code	Basamak Sayısı Number of Steps	Profil Profile	1 Kademe Yükseklik 1 Section Height	2 Kademe Yükseklik 2 Section Height	2 Kademe A Tipi Yükseklik Section 2 Type A Height	Dıştan Dışa Genişlik Out-To-Out Width	Ambalajlı Ölçüleri Packed Size			Ağırlık Weight	1 Adet m <sup>3</sup> 1 Pcs. m <sup>3</sup>
								a	b	c		
8695849009509	7207-A	2x7	60x20	1930	3010	1815	355/410	420	120	1980	8,00	0,10
8695849009486	7209-A	2x9	60x20	2470	4090	2325	355/410	420	120	2520	10,10	0,13
8695849009462	7211-A	2x11	70x20	3010	5170	2830	355/410	420	135	3060	12,70	0,18
8695849009448	7213-A	2x13	70x20	3550	6250	3330	355/410	420	135	3600	14,60	0,21
8695849009424	7215-A	2x15	80x20	4090	7330	3850	355/410	420	145	4140	19,80	0,26

## 2 KADEME SÜRGÜLÜ ALÜMİNYUM ENDÜSTRİYEL MERDİVEN 2 SECTIONAL INDUSTRIAL LADDER (SLIDING TYPE)



### 2 KADEMELİ SÜRGÜLÜ ALÜMİNYUM ENDÜSTRİYEL MERDİVEN

- Özel alaşımlı alüminyum merdiven
- 2 kademeli kullanım
- Kolay açılıp kapanabilme
- Tek parçalı kullanım
- Kullanıma hazır tek şıklı ambalaj
- Kaymayı önleyen özel tasarımlı basamaklar
- Endüstriyel amaçlı kullanım
- Uzun ömürlü paslanmaz maksimum mukavemet
- Basamakların maksimum mukavemetini ve dengesini sağlamak için profil bağlantı noktasında çift taraflı şişirme

### 2 SECTIONAL INDUSTRIAL LADDER (SLIDING TYPE)

- Special alloyed aluminum ladder
- 2 Sectional usage
- Can be used as single section
- Practical folding away
- Ready to use stylish single pack
- Exclusively designed steps which prevents slipping
- Can be used for Industrial Purpose
- Durable, rustproof, maximum strength
- Double sided inflating at profile point to provide the maximum strength and balance of the steps

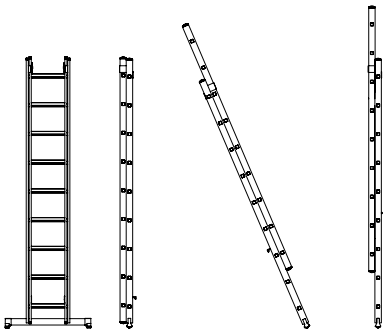

Certificate  
EN 131  
Norm

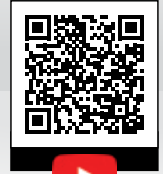

Barkod Barcode	Kod Code	Basamak Sayısı Number of Steps	Profil Profile	1 Kademe Yükseklik 1 Section Height	2 Kademe Yükseklik 2 Section Height	Dıştan Dışa Genişlik Out-To-Out Width	Ambalajlı Ölçüleri Packed Size			Ağırlık Weight	1 Adet m <sup>3</sup> 1 Pcs. m <sup>3</sup>
							a	b	c		
8695849009882	7207-S	2x7	60x20	1930	3010	355/410	420	120	1980	7,31	0,10
8695849009868	7209-S	2x9	60x20	2470	4090	355/410	420	120	2520	9,47	0,13
8695849009844	7211-S	2x11	70x20	3010	5170	355/410	420	135	3060	12,00	0,18
8695849009820	7213-S	2x13	70x20	3550	6250	355/410	420	135	3600	13,85	0,21
8695849009806	7215-S	2x15	80x20	4090	7330	355/410	420	145	4140	19,00	0,26

## ÇİFT SÜRGÜLÜ ALÜMİNYUM ENDÜSTRİYEL MERDİVEN DOUBLE SLIDING INDUSTRIAL LADDER

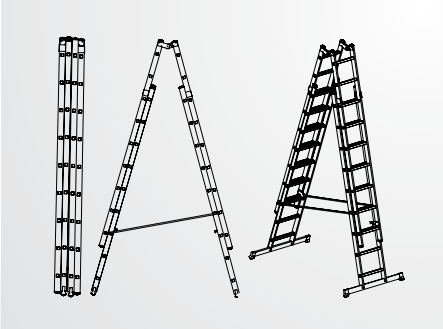

## ÇİFT SÜRGÜLÜ ALÜMİNYUM ENDÜSTRİYEL MERDİVEN

- Özel alaşımlı alüminyum merdiven
- 2 kademeli kullanım
- Kolay açılıp kapanabilme
- Tek parçalı kullanım
- Kullanıma hazır tek şıklı ambalaj
- Kaymayı önleyen özel tasarımı basamaklar
- Endüstriyel amaçlı kullanım
- Uzun ömürlü paslanmaz maksimum mukavemet
- Basamakların maksimum mukavemetini ve dengesini sağlamak için profil bağlantı noktasında çift taraflı şişirme

## DOUBLE SLIDING INDUSTRIAL LADDER

- Special alloyed aluminum ladder
- 2 Sectional usage
- Can be used as single section
- Practical folding away
- Ready to use stylish single pack
- Exclusively designed steps which prevents slipping
- Can be used for Industrial Purpose
- Durable, rustproof, maximum strength
- Double sided inflating at profile point to provide the maximum strength and balance of the steps

Barkod Barcode	Kod Code	Basamak Sayısı Number of Steps	Profil Profile	1 Kademe Yükseklik 1 Section Height	2 Kademe A Tipi Yükseklik Section 2 Type A Height	Dıştan Dışa Genişlik Out-To-Out Width	Alır Aparat Ölçüsü Lowe Kit Size	Ambalajlı Ölçüleri Packed Size			Ağırlık Weight	1 Adet m <sup>3</sup> 1 Pcs. m <sup>3</sup>
								a	b	c		
8695849008182	7407	2x7	60x20	1930	3010	355/410	800	420	240	1980	16,00	0,20
8695849008175	7409	2x9	60x20	2470	4090	355/410	1000	420	240	2520	20,32	0,26
8695849008168	7411	2x11	70x20	3010	5170	355/410	1000	420	270	3060	25,44	0,35
8695849008151	7413	2x13	70x20	3550	6250	355/410	1000	420	270	3600	29,00	0,42
8695849008144	7415	2x15	80x20	4090	7330	355/410	1200	420	290	4140	39,41	0,50

A TİPİ PLATFORMLU ALÜMİNYUM ENDÜSTRİYEL MERDİVEN  
A TYPE PLATFORM INDUSTRIAL LADDERA TİPİ PLATFORMLU  
ALÜMİNYUM ENDÜSTRİYEL MERDİVEN

- Özel alaşımli alüminyum merdiven
- Kolay açılıp kapanabilme
- Kullanıma hazır tek şıklı ambalaj
- Kaymayı önleyen özel tasarımlı basamaklar
- Endüstriyel amaçlı kullanım
- Uzun ömürlü Paslanmaz maksimum mukavemet

A TYPE PLATFORM  
INDUSTRIAL LADDER

- Special alloyed aluminum ladder
- Pratical folding away
- Ready to use stylish single pack
- Exclusively designed steps which prevents slipping
- Can be used for Industrial Purpose
- Durable,rustproof, maximum strenght

Barkod	Kod	Basamak Sayısı	Profil	2 Kademe A Tipi Yükseklik	Dıştan Dışa Genişlik	Ambalajlı Ölçüleri			Ağırlık	1 Adet m <sup>3</sup>
Barcode	Code	Number of Steps	Profile	Section 2 Type A Height	Out-To-Out Width	a	b	c	Weight	1 Pcs. m <sup>3</sup>
8695849007666	6207	2x7	60x20	1815	410/410	420	120	1980	9,00	0,10
8695849007659	6211	2x11	70x20	2830	410/410	420	120	2520	14,00	0,12
8695849007642	6215	2x15	80x25	3850	410/410	420	135	3060	23,00	0,18



## 2 KADEMELİ İPLİ MAKARALI ENDÜSTRİYEL MERDİVEN ROTARY ROLLING INDUSTRIAL LADDER

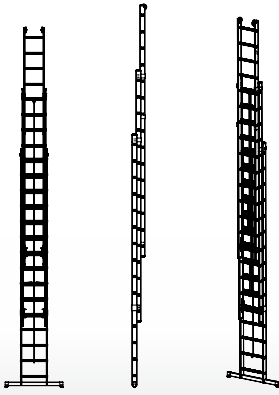

## 2 KADEMELİ İPLİ MAKARALI ALÜMİNYUM ENDÜSTRİYEL MERDİVEN

- Özel alaşımlı alüminyum merdiven
- 2 kademeli kullanım
- Kolay açılıp kapanabilme
- Tek parçalı kullanım
- Kullanıma hazır tek şıklı ambalaj
- Kaymayı önleyen özel tasarımı basamaklar
- Endüstriyel amaçlı kullanım
- Uzun ömürlü Paslanmaz maksimum mukavemet
- Basamakların maksimum mukavemetini ve dengesini sağlamak için profil bağlantı noktasında çift taraflı şişirme

## ROTARY ROLLING INDUSTRIAL LADDER

- Special alloyed aluminum ladder
- 2 Sectional usage
- Can be used as single section
- Pratical folding away
- Ready to use stylish single pack
- Exclusively designed steps which prevents slipping
- Can be used for Industrial Purpose
- Durable, rustproof, maximum strenght
- Double sided inflating at profile point to provide the maximum strenght and balance of the steps



Barkod Barcode	Kod Code	Basamak Sayısı Number of Steps	Profil Profile	1 Kademe Yükseklik 1 Section Height	2 Kademe Yükseklik 2 Section Height	Dıştan Dışa Genişlik Out-To-Out Width	Alt Aparat Ölçüsü Lowe Kit Size	Ambalajlı Ölçüleri Packed Size			Ağırlık Weight	1 Adet m <sup>3</sup> 1 Pcs. m <sup>3</sup>
								a	b	c		
8695849007703	6111	2x11	70x20	3010	5170	355/410	1000	420	140	3010	13,00	0,180
8695849007697	6115	2x15	80x20	4090	7330	410/465	1200	420	160	4090	20,00	0,210
8695849007680	6119	2x19	80x25	5170	9500	410/465	1200	420	160	5170	28,50	0,330
8695849007673	6122	2x22	80x25	5980	11120	410/465	1200	420	160	6000	34,00	0,420

### 3 AYAKLI BAĞÇE MERDİVENİ THREE LEGGED GARDEN LADDER



### 3 AYAKLI BAĞÇE MERDİVENİ

- Özel alaşımli alüminyum merdiven
- Kolay açılıp kapanabilme
- Tek parça kullanım
- Kullanıma hazır tek şıklı ambalaj
- Kaymayı önleyen özel tasarımı basamaklar
- Endüstriyel amaçlı kullanım
- Uzun ömürlü

### THREE LEGGED GARDEN LADDER

- Special alloyed aluminum ladder
- Can be used as single section
- Pratical folding away
- Ready to use stylish single pack
- Exclusively designed steps which prevents slipping
- Can be used for Industrial Purpose
- Durable,rust proof, maximum strenght

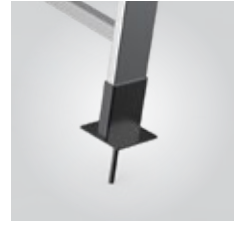

Barkod Barcode	Kod Code	Basamak Sayısı Number of Steps	Profil Profile	A Tipi Yükseklik Type A Height	Ambalajlı Ölçüleri Packed Size			Ağırlık Weight	1 Adet m <sup>3</sup> 1 Pcs. m <sup>3</sup>
					a	b	c		
8695849007635	6309	1x9	60x20	1815	2500	120	500	7,00	0,15
8695849007628	6311	1x11	70x20	2830	3000	130	600	10,90	0,23
8695849007611	6315	1x15	80x20	3850	4000	140	800	14,20	0,45

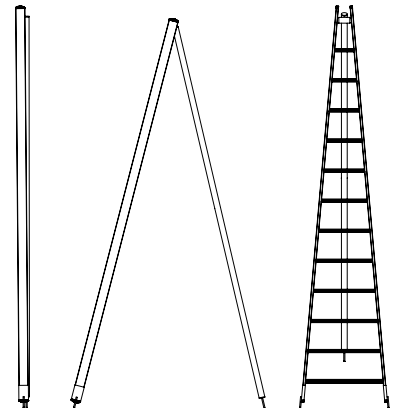

## TEK KADEMELİ ENDÜSTRİYEL MERDİVEN ONE SECTION INDUSTRIAL LADDER



Certificate  
**EN 131**  
Norm

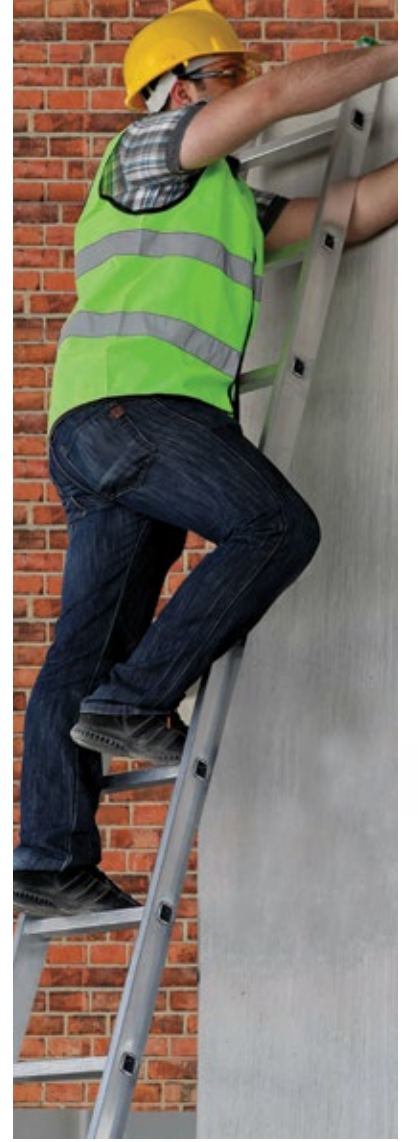

### TEK KADEMELİ ENDÜSTRİYEL MERDİVEN

- Özel alaşımli alüminyum merdiven
- Kullanıma hazır tek şıklı ambalaj
- Kaymayı önleyen özel tasarımı basamaklar
- Endüstriyel amaçlı kullanım
- Uzun ömürlü Paslanmaz maksimum mukavemet

### ONE SECTION INDUSTRIAL LADDER

- Special alloyed aluminum ladder
- Ready to use stylish single pack
- Exclusively designed steps which prevents slipping
- Can be used for Industrial Purpose
- Durable, rustproof, maximum strenght



Barkod Barcode	Kod Code	Basamak Sayısı Number of Steps	Profil Profile	1 Kademe Yükseklik 1 Section Height	Dıştan Dışa Genişlik Out-To-Out Width	Denge Ayağı Out-To-Out Width	Ambalajlı Olçüleri Packed Size			Ağırlık Weight	1 Adet m <sup>3</sup> 1 Pcs. m <sup>3</sup>
							a	b	c		
8695849009998	7107	1x7	60x20	1930	355	x	365	62	1980	3,00	0,05
8695849009974	7109	1x9	60x20	2470	355	x	365	62	2520	3,79	0,06
8695849009950	7111	1x11	60x20	3010	355	✓	365	62	3060	5,00	0,07
8695849009936	7113	1x13	70x20	3550	410	✓	420	72	3600	7,90	0,11
8695849009912	7115	1x15	80x20	4090	410	✓	420	82	4140	9,81	0,15

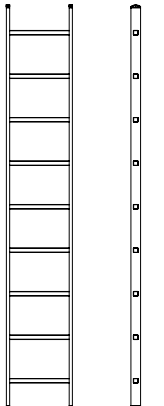



KORKULUKLU ALÜMİNYUM ENDÜSTRİYEL MERDİVEN  
ALUMINIUM ONE SECTIONAL RAILED INDUSTRIAL LADDERKORKULUKLU  
ALÜMİNYUM ENDÜSTRİYEL MERDİVEN

- Özel alaşımlı alüminyum merdiven
- Kullanıma hazır tek şıklı ambalaj
- Kaymayı önleyen özel tasarımı basamaklar
- Endüstriyel amaçlı kullanım
- Uzun ömürlü paslanmaz maksimum mukavemet

ALUMINIUM ONE SECTIONAL  
RAILED INDUSTRIAL LADDER

- Special alloyed aluminum ladder
- Ready to use stylish single pack
- Exclusively designed steps which prevents slipping
- Can be used for Industrial Purpose
- Durable, rust proof, maximum strenght

Barkod	Kod	Basamak Sayısı	Profil	1 Kademe Yükseklik	Dıştan Dışa Genişlik	Ambalajlı Ölçüleri			Ağırlık	1 Adet m <sup>3</sup>
Barcode	Code	Number of Steps	Profile	1 Section Height	Out-To-Out Width	Packed Size			Weight	1 Pcs. m <sup>3</sup>
						a	b	c		
8699897397502	7107-K	1x7	60x20	1930	355	365	162	1980	4,50	0,11
8699897397519	7109-K	1x9	60x20	2470	355	365	162	2520	6,00	0,14
8699897397526	7111-K	1x11	60x20	3010	355	365	162	3060	7,50	0,18
8699897397533	7113-K	1x13	70x20	3550	410	420	172	3600	10,50	0,26
8699897397540	7115-K	1x15	80x20	4090	410	420	182	4140	13,50	0,31

## SARAYLI ÇOK AMAÇLI MERDİVEN SARAYLI MULTI-FUNCTIONAL LADDER

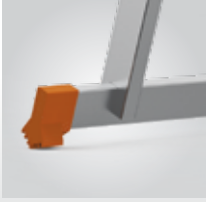

## SARAYLI ÇOK AMAÇLI MERDİVEN

- Özel alaşımlı alüminyum merdiven
- Akıllı kilit sistemi sayesinde çok amaçlı kullanım
- Katlanabilmesi sayesinde az yer kaplar
- Kolay açılıp kapanabilme özelliği
- Kaymayı önleyen özel tasarımı basamaklar
- Endüstriyel amaçlı kullanım
- Uzun ömürlü Paslanmaz maksimum mukavemet

## SARAYLI MULTI-FUNCTIONAL LADDER

- Special alloyed aluminum ladder
- Multi-purpose usage thanks to the smart locking system
- Folding structure provides less space consumption when the ladder is folded
- Practical folding away
- Exclusively designed steps which prevents slipping
- Can be used for Industrial Purpose
- Durable, rust proof, maximum strenght



Barkod Barcode	Kod Code	Basamak Sayısı Number of Steps	Profil Profile	M Tipi M Type	A Tipi A Type	Platform	Açık Open	Ambalajlı Ölçüleri Packed Size			Ağırlık Weight	1 Adet m <sup>3</sup> 1 Pcs. m <sup>3</sup>
								a	b	c		
8695849009332	7612	4x3	60x25	900	1800	950	3500	380	275	1010	12,6	0,11
8695849009325	7616	4x4	60x25	1100	2300	1220	4500	380	275	1255	13,5	0,14
8695849009226	7620	4x5	60x25	1400	2800	1470	5600	380	275	1520	14,4	0,17

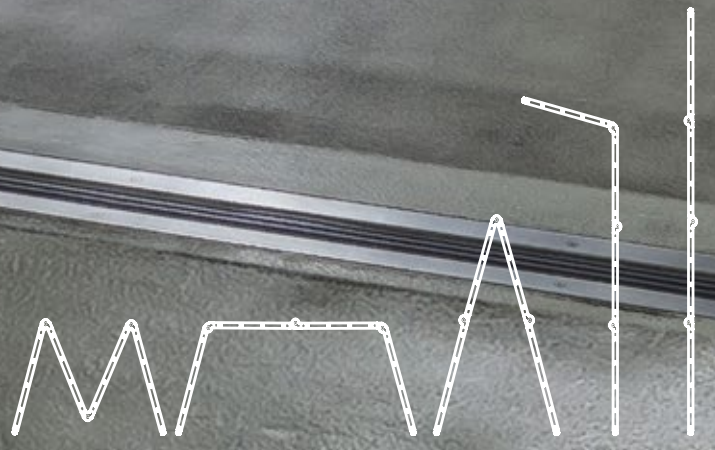

## İKİ PARÇALI ALÜMİNYUM KATLANIR MERDİVEN TWO PIECE ALUMINUM FOLDING LADDER



**2 PARÇALI**  
TWO PIECE



**KATLANIR**  
FOLDING

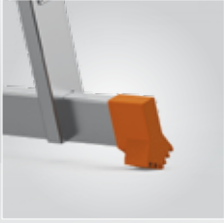

## İKİ PARÇALI ALÜMİNYUM KATLANIR MERDİVEN

- Özel alaşımli alüminyum merdiven
- Akıllı kilit sistemi sayesinde çok amaçlı kullanım
- Katlanabilmesi sayesinde az yer kaplar
- Kolay açılıp kapanabilme özelliği
- Kaymayı önleyen özel tasarımı basamaklar
- Endüstriyel amaçlı kullanım
- Uzun ömürlü Paslanmaz maksimum mukavemet

## TWO PIECE ALUMINUM FOLDING LADDER

- Special alloyed aluminum ladder
- Multi-purpose usage thanks to the smart locking system
- Folding structure provides less space consumption when the ladder is folded
- Practical folding away
- Exclusively designed steps which prevents slipping
- Can be used for Industrial Purpose
- Durable, rust proof, maximum strenght

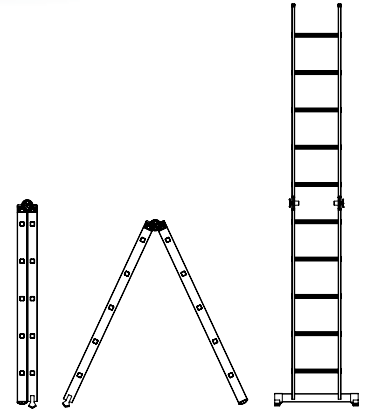

Barkod Barcode	Kod Code	Basamak Sayısı Number of Steps	Profil Profile	Açık Open	A Tipi A Type	Ambalajlı Ölçüleri Packed Size			1 Adet m <sup>3</sup> 1 Pcs. m <sup>3</sup>
						a	b	c	
8695849007376	7603	<b>2x3</b>	70x20	1800	805	145	360	980	0,07
8695849007369	7605	<b>2x5</b>	70x20	2900	1330	145	360	1520	0,13
8695849007352	7607	<b>2x7</b>	70x20	3950	1850	145	360	2060	0,17



## SARAYLI MOTTO Merdİven

- Özel alaşımli alüminyum merdiven
- Kaymayı önleyen özel tasarımı basamaklar
- Endüstriyel ve konfor amaçlı kullanım
- Uzun ömürlü paslanmaz maksimum mukavemet
- Geniş platformu sayesinde rahat hareket edebilme

## SARAYLI MOTTO ALUMINUM FOLDING LADDER

- Special alloyed aluminum ladder
- Special designed steps which prevents slipping
- Can be used for Industrial Purpose
- Durable, rustproof and maximum endurance
- Safety rail system



Barkod Barcode	Kod Code	Profil Profile	Yükseklik Height	Ürün Ebadi Product Size			Platform Ebadi Platform Size	Ambalajlı Ölçüleri Packed Size			Ağırlık Weight	1 Adet m <sup>3</sup> 1 Pcs. m <sup>3</sup>
				a	b	c		a	b	c		
8699897397656	7636	60x20	360	1200	450	360	950X410	1000	450	130	6,3	0,058
8699897397663	7648	60x20	480	1600	450	480	1250X410	1250	450	130	8,3	0,073
8699897397690	7660	60x20	600	2000	450	600	1500X410	1500	450	130	10,5	0,087

## TELESKOPIK MERDİVEN TELESCOPIC LADDER

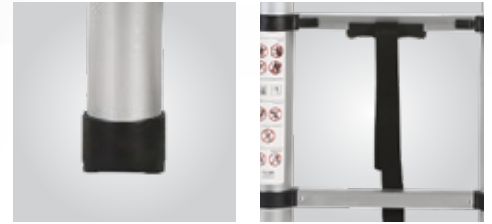

## TELESKOPIK MERDİVEN

- Özel alaşımli alüminyum merdiven
- Akıllı kilit sistemi sayesinde çok amaçlı kullanım
- Katlanabilmesi sayesinde az yer kaplar
- Kolay açılıp kapanabilme özelliği
- Kaymayı önleyen özel tasarımı basamaklar
- Endüstriyel amaçlı kullanım
- Uzun ömürlü Paslanmaz maksimum mukavemet

## TELESCOPIC LADDER

- Special alloyed aluminum ladder
- Multi-purpose usage thanks to the smart locking system
- Folding structure provides less space consumption when the ladder is folded
- Practical folding away
- Exclusively designed steps which prevents slipping
- Can be used for Industrial Purpose
- Durable, rust proof, maximum strength

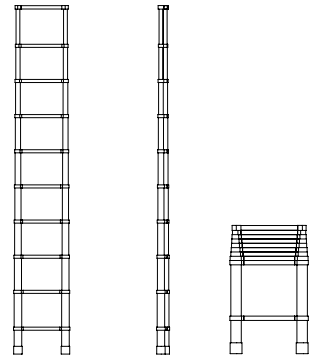

Barkod Barcode	Kod Code	Basamak Sayısı Number of Steps	1 Kademe Yükseklik 1 Section Height	Dıştan Dışa Genişlik Out-To-Out Width	Ambalajlı Ölçüleri Packed Size			Ağırlık Weight	1 Adet m <sup>3</sup> 1 Pcs. m <sup>3</sup>
					a	b	c		
8695849007574	7111-T	<b>1x11</b>	3200	470	810	475	80	8,70	0,03
8695849007567	7113-T	<b>1x13</b>	3800	480	875	480	85	10,70	0,035

TELESKOPIK A TİPİ MERDİVEN  
TELESCOPIC A TYPE LADDERTELESKOPIK A TİPİ  
MERDİVEN

- Özel alaşımlı alüminyum merdiven
- 2 kademeli kullanım
- Kolay açılıp kapanabilme
- Tek parça kullanım
- Kullanıma hazır tek şıklı ambalaj
- Kaymayı önleyen özel tasarımı basamaklar
- Endüstriyel amaçlı kullanım
- Uzun ömürlü
- Basamakların maksimum mukavemetini ve dengesini sağlamak için profil bağlantı noktasında çift taraflı şişirme

TELESCOPIC A TYPE  
LADDER

- Special alloyed aluminum ladder
- 2 sectional usage
- Can be used as single section
- Practical folding away
- Ready to use stylish single pack
- Exclusively designed steps which prevents slipping
- Can be used for Industrial Purpose
- Durable, rust proof, maximum strength
- Double sided inflating at profile point to provide the maximum strength and balance of the steps

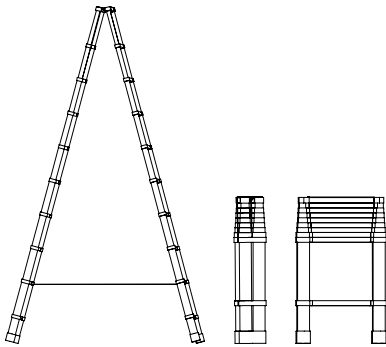

Barkod

Barcode

8695849007581



Kod

Code

7210-T

Basamak  
SayısıNumber of  
Steps

1x10

1 Kademe  
Yükseklik1 Section  
Height

2800

Dıştan Dışa  
GenişlikOut-To-Out  
Width

520

Ambalajlı  
Ölçüleri

Packed Size

a	b	c
810	520	180



Ağırlık

Weight

14,60

1 Adet m<sup>3</sup>1 Pcs. m<sup>3</sup>

0,76

FİBERGLASS AKROBAT MERDİVEN  
FİBERGLASS ACROBAT LADDER

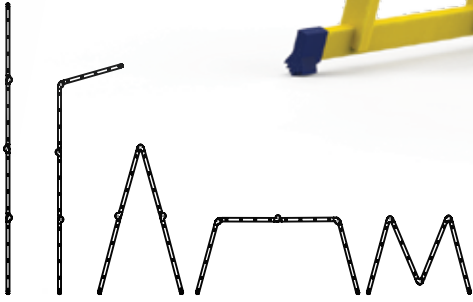

## FİBERGLASS AKROBAT MerdİVEN

- Fiberglass Merdiven
- Akıllı kilit sistemi sayesinde çok amaçlı kullanım
- Katlanabilmesi sayesinde az yer kaplar
- Kolay açılıp kapanabilme özelliği
- Kaymayı önleyen özel tasarımlı basamaklar
- Endüstriyel amaçlı kullanım
- Uzun ömürlü paslanmaz maksimum mukavemet

## FİBERGLASS ACROBAT LADDER

- Fiberglass ladder
- Multi-purpose usage thanks to the smart locking system
- Folding structure provides less space consumption when the ladder is folded
- Practical folding away
- Exclusively designed steps which prevents slipping
- Can be used for Industrial Purpose
- Durable, rust proof, maximum strenght

Barkod	Kod	Basamak Sayısı	Profil	Açık	A Tipi	Platform	Ambalajlı Ölçüleri			Ağırlık	1 Adet m <sup>3</sup>
Barcode	Code	Number of Steps	Profile	Open	A Type	Platform	Packed Size			Weight	1 Pcs. m <sup>3</sup>
							a	b	c		
8695849007604	7612-F	<b>4x3</b>	63x25	3690	1800	1800	360	250	960	14,6	0,11
8695849007598	7616-F	<b>4x4</b>	63x25	4675	2300	2250	360	275	1255	16,9	0,14



**İSKELE  
MERDİVEN  
GRUBU**

**SCAFFOLDING  
LADDER  
GROUP**



**Saraylı**

tam düşündüğünüz gibi | just as you thought

ALÜMİNYUM MEGA İSKELE  
ALUMINIUM MEGA SCAFFOLDING



Certificate  
EN 1004  
Norm

## ALÜMİNYUM MEGA İSKELE

- Özel alaşımı alüminyum iskele merdiven
- Platform sayesinde rahat hareket edebilme
- Tekerler sayesinde rahat hareket edebilme ve sabitleme
- Ayarlanabilir ayak sistemi
- İp ve makara sistem sayesinde istenilen yüksekliğe kolay hareket edebilme
- Kilit sistemi sayesinde istenilen yükseklikte durma
- Platform kapak sayesinde kısa sürede istenilen çalışma ortamına ulaşma
- Yan kollar sayesinde emniyeti sağlama ve sallantıyı engelleme
- Kolay sökülüp takılabilmeye ve demonte hale gelebilme
- Kaymayı önleyen özel tasarımı basamaklar ve platform
- Uzun ömürlü Paslanmaz maksimum mukavemet

## ALUMINIUM MEGA SCAFFOLDING

- Special alloyed aluminum ladder
- Easy movement thanks to platform
- With wheels, easy mobility and anchorage
- Adjustable leg system
- With rope and spool system, easy access to the intended height
- Adjust the height through the locking device to the requested level
- Thanks to platform cover, easy access to the intended work environment
- in short time
- Thanks to side bars providing safety and shake prevention
- Easy to assemble and disassemble
- Exclusively designed steps which prevents slipping
- Durable, rust proof, maximum strenght

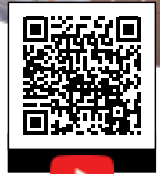
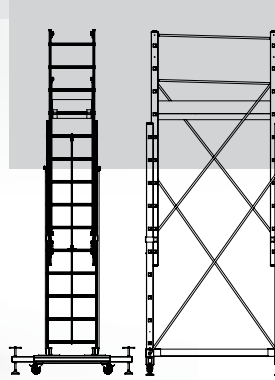
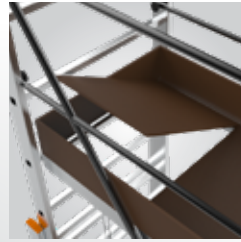

Barkod	Kod	Basamak Sayısı	Platform Sayısı	Profil	Max. Platform Yüksekliği	Çalışma Yüksekliği	Ayakların Açıldığı Min - Max Genişlik	Dıştan Dışa Genişlik
Barcode	Code	Number of Steps	Number of Platform	Profile	Max. Platform Height	Working Height	Min - Max. Width When Legs Are Opened	Out-To-Out Width
8695849008243	7507	<b>(2x7)+(2x7)</b>	1	80x25	2050	3850	1150-1900	1850
8695849009264	7509	<b>(2x9)+(2x9)</b>	1	80x25	3130	4930	1150-1900	1850
8695849009257	7511	<b>(2x11)+(2x11)</b>	2	80x25	4210	6010	1150-1900	1850
8695849009240	7513	<b>(2x13)+(2x13)</b>	2	80x25	5020	6820	1165-2400	1850
8695849009233	7515	<b>(2x15)+(2x15)</b>	3	80x25	6100	7900	1165-2400	1850
8695849008236	7519	<b>(2x19)+(2x19)</b>	4	80x25	8260	10063	1165-2400	1850

Certificate  
**EN 1004**  
Norm

## ALÜMİNYUM MEGA TP İSKELE

- Özel alaşımli alüminyum iskele merdiven
- Platform sayesinde rahat hareket edebilme
- Tekerler sayesinde rahat hareket edebilme ve sabitleme
- Ayarlanabilir ayak sistemi
- İp ve makara sistem sayesinde istenilen yüksekliğe kolay hareket edebilme
- Kilit sistemi sayesinde istenilen yükseklikte durma
- Platform kapak sayesinde kısa sürede istenilen çalışma ortamına ulaşma
- Yan kollar sayesinde emniyeti sağlama ve sallantıyı engelleme
- Kolay sökülüp takılabilmeye ve demonte hale gelebilme
- Kaymayı önleyen özel tasarımı basamaklar ve platform
- Uzun ömürlü Paslanmaz maksimum mukavemet

## ALUMINIUM MEGA TP SCAFFOLDING

- Special alloyed aluminum ladder
- Easy movement thanks to platform
- With wheels, easy mobility and anchorage
- Adjustable leg system
- With rope and spool system, easy access to the intended height
- Adjust the height through the locking device to the requested level
- Thanks to platform cover, easy access to the intended work environment
- in short time
- Thanks to side bars providing safety and shake prevention
- Easy to assemble and disassemble
- Exclusively designed steps which prevents slipping
- Durable, rust proof, maximum strength

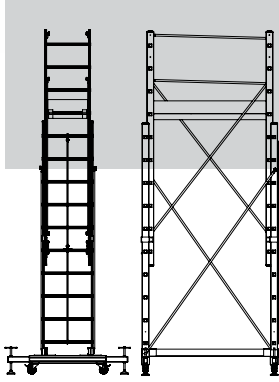
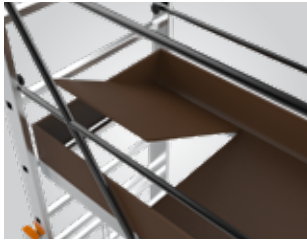
DEMONTÉ HALI  
DISASSEMBLED STATEPlatform Ebadı  
Platform Size  
**160x60cm**ALÜMİNYUM MEGA TP İSKELE  
ALUMINIUM MEGA TP SCAFFOLDING

Barkod	Kod	Basamak Sayısı	Platform Sayısı	Profil	Max. Platform Yüksekliği	Çalışma Yüksekliği	Ayakların Açıldığı Min - Max Genişlik	Diştan Dışa Genişlik	Ağırlık	1 Adet m <sup>3</sup>
Barcode	Code	Number of Steps	Number of Platform	Profile	Max. Platform Height	Working Height	Min - Max. Width When Legs Are Opened	Out-To-Out Width	Weight	1 Pcs. m <sup>3</sup>
8699897397939	7511-M	<b>(2x11)+(2x11)</b>	1	80x25	4210	6010	1150-1900	1850	75,00	1,2
8699897397946	7513-M	<b>(2x13)+(2x13)</b>	1	80x25	5020	6820	1165-2400	1850	80,00	1,3
8699897397953	7515-M	<b>(2x15)+(2x15)</b>	1	80x25	6100	7900	1165-2400	1850	90,00	1,4
8699897397960	7519-M	<b>(2x19)+(2x19)</b>	1	80x25	8260	10063	1165-2400	1850	100,00	1,5

TS EN 1004:2006 Standardına Uygundur.

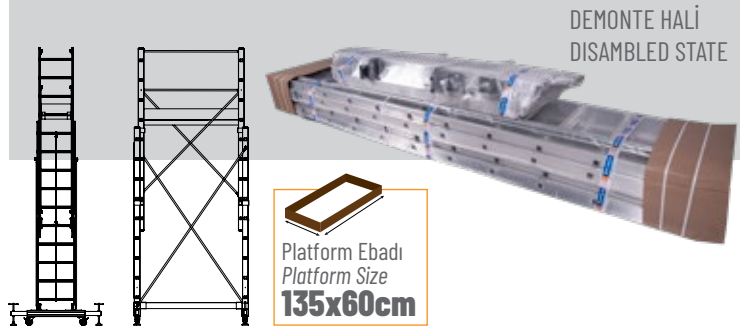
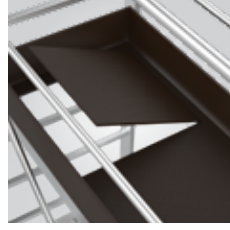

## ALÜMİNYUM İSKELE

- Özel alaşımlı alüminyum iskele merdiven
- Platform sayesinde rahat hareket edebilme
- Tekerler sayesinde rahat hareket edebilme ve sabitleme
- Ayarlanabilir ayak sistemi
- İp ve makara sistem sayesinde istenilen yüksekliğe kolay hareket edebilme
- Kilit sistemi sayesinde istenilen yükseklikte durma
- Platform kapak sayesinde kısa sürede istenilen çalışma ortamına ulaşma
- Yan kollar sayesinde emniyeti sağlama ve sallantıyı engelleme
- Kolay sökülüp takılabilme ve demonte hale gelebilme
- Kaymayı önleyen özel tasarımı basamaklar ve platform
- Uzun ömürlü Paslanmaz maksimum mukavemet

## ALUMINIUM SCAFFOLDING

- Special alloyed aluminum ladder
- Easy movement thanks to platform
- With wheels, easy mobility and anchorage
- Adjustable leg system
- With rope and spool system, easy access to the intended height
- Adjust the height through the locking device to the requested level
- Thanks to platform cover, easy access to the intended work environment
- in short time
- Thanks to side bars providing safety and shake prevention
- Easy to assemble and disassemble
- Exclusively designed steps which prevents slipping
- Durable, rust proof, maximum strenght



Barkod Barcode	Kod Code	Basamak Sayısı Number of Steps	Profil Profile	Max. Platform Yüksekliği Max. Platform Height	Çalışma Yüksekliği Working Height	Ayakların Açıldığı Min-Max Genişlik Min-Max. Width When Legs Are Opened	Dişan Dışa Genişlik Out-To-Out Width	Ağırlık Weight	1 Adet m <sup>3</sup> 1 Pcs. m <sup>3</sup>
8695849008083	7507-D	<b>(2x7)+(2x7)</b>	80x20	2050	3850	1150-1900	1600	77,00	0,9
8695849008076	7509-D	<b>(2x9)+(2x9)</b>	80x20	3130	4930	1150-1900	1600	86,00	1,0
8695849008069	7511-D	<b>(2x11)+(2x11)</b>	80x20	4210	6010	1150-1900	1600	95,00	1,1

## ALÜMİNYUM TEKLİ İSKELE

- Özel alaşımlı alüminyum iskele merdiven
- Platform sayesinde rahat hareket edebilme
- Tekerler sayesinde rahat hareket edebilme ve sabitleme
- Platform kapak sayesinde kısa sürede istenilen çalışma ortamına ulaşma
- Yan kollar sayesinde emniyeti sağlama ve sallantıyı engelleme
- Kolay sökülüp takılabilme ve demonte hale gelebilme
- Kaymayı önleyen özel tasarımı basamaklar ve platform
- Uzun ömürlü Paslanmaz maksimum mukavemet

## SINGLE STEP ALUMINIUM SCAFFOLDING

- Special alloyed aluminum ladder
- Easy movement thanks to platform
- With wheels, easy mobility and anchorage
- Thanks to platform cover, easy access to the intended work environment in short time
- Thanks to side bars providing safety and shake prevention
- Easy to assemble and disassemble
- Exclusively designed steps which prevents slipping
- Durable, rust proof, maximum strength



DEMONTE HALİ  
DISASSEMBLED STATE

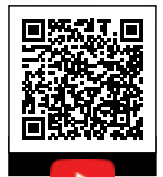

Barkod	Kod	Basamak Sayısı	Profil	1 Kademe Yükseklik	Ayakların Açıldığı Max Genişlik	Dıştan Dışa Genişlik	Ağırlık	1 Adet m <sup>3</sup>
Barcode	Code	Number of Steps	Profile	1 Section Height	Max. Width When Legs Are Opened	Out-To-Out Width	Weight	1 Pcs. m <sup>3</sup>
8695849008137	7507-T	<b>(1x7)+(1x7)</b>	80x25	2020	1000	1600	30,0	0,5
8695849008120	7509-T	<b>(1x9)+(1x9)</b>	80x25	2520	1000	1600	34,5	0,6
8695849008113	7511-T	<b>(1x11)+(1x11)</b>	80x25	3020	1000	1600	37,0	0,75
8695849008106	7513-T	<b>(1x13)+(1x13)</b>	80x25	3520	1000	1600	42,0	0,9
8695849008090	7515-T	<b>(1x15)+(1x15)</b>	80x25	4020	1200	1600	47,0	1,05

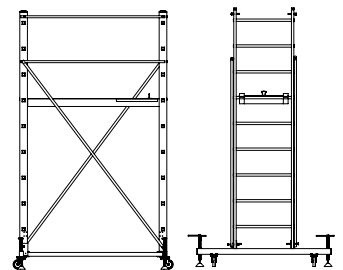

PROFESYONEL PLUS İSKELE  
PROFESSIONAL PLUS SCAFFOLDING



Certificate  
**EN 1004**  
Norm



**PROFESYONEL PLUS**  
İSKELE

- Özel alaşımli alüminyum merdiven
- Kaymayı önleyen özel tasarımı basamaklar
- Endüstriyel amaçlı kullanım
- Uzun ömürlü paslanmaz maksimum mukavemet
- Güvenli korkuluk sistemi
- Tekerler ve sabitleme ayaklar sayesinde rahat hareket edebilme ve sabitleme
- Geniş platformu sayesinde rahat hareket edebilme

**PROFESSIONAL PLUS**  
SCAFFOLDING

- Special alloyed aluminium ladder
- Exclusively designed steps which prevents slipping
- Used for Industrial purposes
- Long durable, Rustproof, maximum durability
- Safety railing system
- Loose movement and stabilizing through the wheels and stabilizing foot
- Loose movement through the wide platform



DEMONTE HALİ  
DISASSEMBLED STATE



Opsiyonel  
Optional

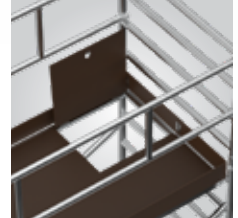

Platform Ebadı  
Platform Size  
**225x110 cm**

Barkod Barcode	Kod Code	İskele Yüksekliği Scaffolding Height	İskele Genişliği Scaffolding Width	Yan Genişlik Side Width	Max. Platform Yüksekliği Max. Platform Height	Çalışma Yüksekliği Working Height
8695849008397	8804	3210	1270	2390	2095	4095
8695849008380	8806	5200	1270	2390	4085	6085
8695849008373	8808	7190	1270	2390	6075	8075
8695849008366	8810	9180	1270	2390	8065	10065
8695849008526	8812	11170	1270	2390	10055	12055



Certificate  
**EN 1004**  
Norm

PROFESYONEL İSKELE  
PROFESSIONAL SCAFFOLDING

## PROFESYONEL İSKELE

- Özel alaşımli alüminyum merdiven
- Kaymayı önleyen özel tasarımı basamaklar
- Endüstriyel amaçlı kullanım
- Uzun ömürlü paslanmaz maksimum mukavemet
- Güvenli korkuluk sistemi
- Tekerler ve sabitleme ayaklar sayesinde rahat hareket edebilme ve sabitleme
- Geniş platformu sayesinde rahat hareket edebilme

## PROFESSIONAL SCAFFOLDING

- Special alloyed aluminium ladder
- Exclusively designed steps which prevents slipping
- Used for Industrial purposes
- Long durable, Rustproof, maximum durability
- Safety railing system
- Loose movement and stabilizing through the wheels and stabilizing foot
- Loose movement through the wide platform



DEMONTE HALİ  
DISAMBLED STATE

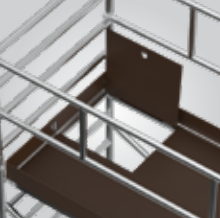

Opsiyonel  
Optional

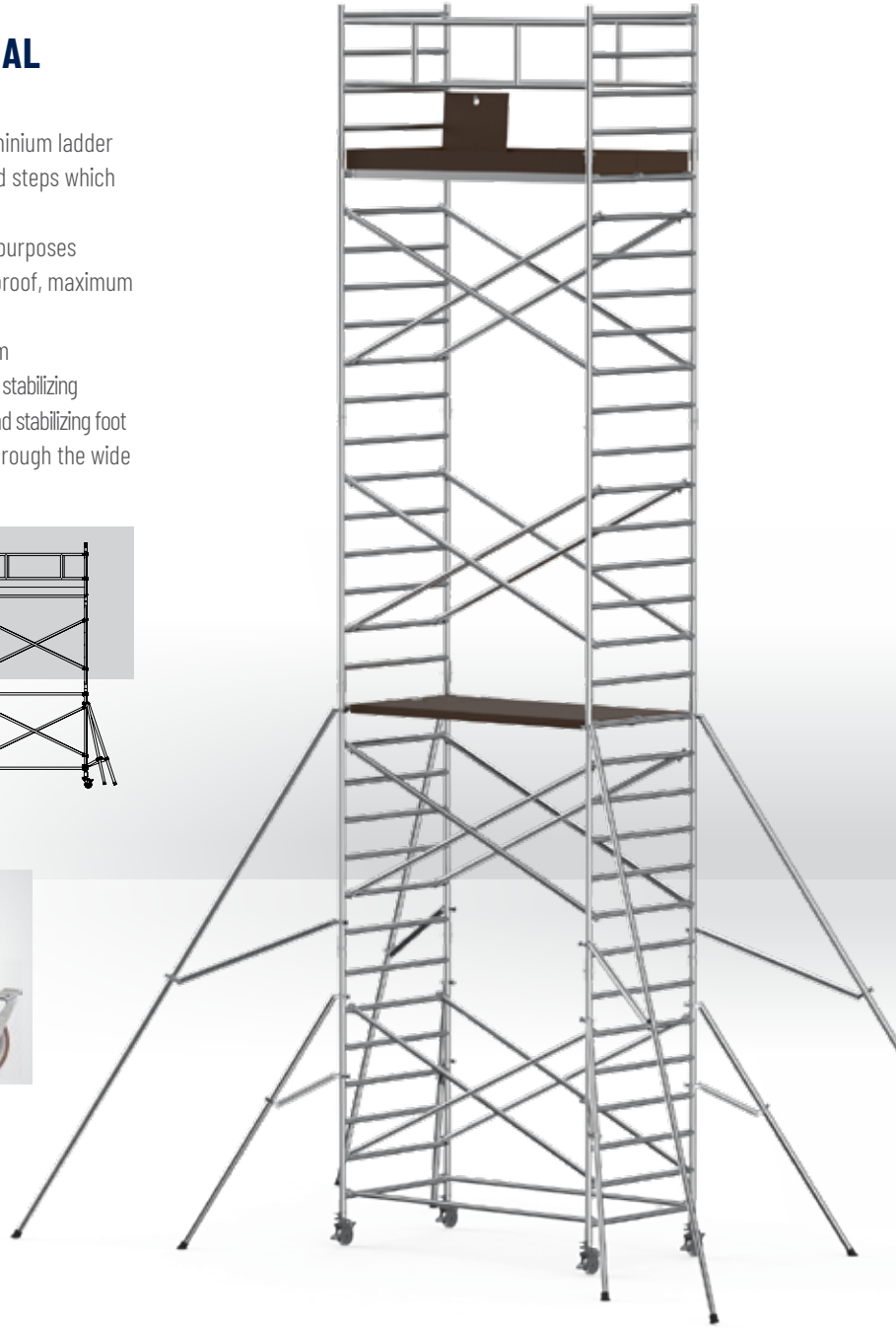

Barkod Barcode	Kod Code	İskele Yüksekliği Scaffolding Height	İskele Genişliği Scaffolding Width	Yan Genişlik Side Width	Max. Platform Yüksekliği Max. Platform Height	Çalışma Yüksekliği Working Height
8699897397939	8804-M	3210	1270	2390	2095	4095
8699897397946	8806-M	5200	1270	2390	4085	6085
8699897397953	8808-M	7190	1270	2390	6075	8075
8699897397960	8810-M	9180	1270	2390	8065	10065
8695849008526	8812-M	11170	1270	2390	10055	12055

PROFESYONEL S İSKELE  
PROFESSIONAL S SCAFFOLDING



Certificate  
**EN 1004**  
Norm



**PROFESYONEL S**  
İSKELE

- Özel alaşımli alüminyum merdiven
- Kaymayı önleyen özel tasarımı basamaklar
- Endüstriyel amaçlı kullanım
- Uzun ömürlü paslanmaz maksimum mukavemet
- Güvenli korkuluk sistemi
- Tekerler ve sabitleme ayaklar sayesinde rahat hareket edebilme ve sabitleme
- Geniş platformu sayesinde rahat hareket edebilme

**PROFESSIONAL S**  
SCAFFOLDING

- Special alloyed aluminium ladder
- Exclusively designed steps which prevents slipping
- Used for Industrial purposes
- Long durable, Rustproof, maximum durability
- Safety railing system
- Loose movement and stabilizing through the wheels and stabilizing foot
- Loose movement through the wide platform



DEMONTE HALİ  
DISAMBLED STATE

Platform Ebadı  
Platform Size  
**190x60 cm**

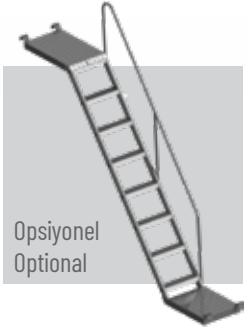
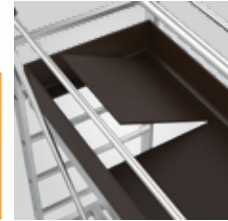

Opsiyonel  
Optional

Barkod Barcode	Kod Code	İskele Yüksekliği Scaffolding Height	İskele Genişliği Scaffolding Width	Yan Genişlik Side Width	Max. Platform Yüksekliği Max. Platform Height	Çalışma Yüksekliği Working Height
8699897398028	8804-S	3210	800	2020	2095	4055
8699897398035	8806-S	5200	800	2020	4085	6085
8699897398042	8808-S	7190	800	2020	6075	8075

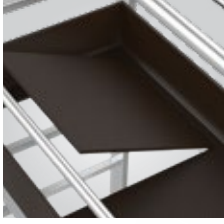
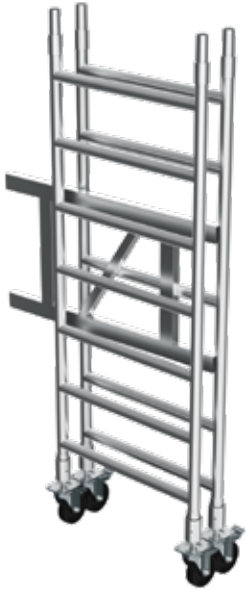
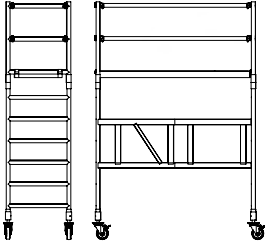

Certificate  
**EN 1004**  
NormPlatform Ebadı  
Platform Size  
**190x60 cm**DEMONTE HALİ  
DISAMBLED STATE

## PROFESYONEL KATLANIR İSKELE

- Özel alaşımli alüminyum iskele merdiven
- Platform sayesinde rahat hareket edebilme
- Tekerler sayesinde rahat hareket edebilme ve sabitleme
- Platform kapak sayesinde kısa sürede istenilen çalışma ortamına ulaşma
- Yan kollar sayesinde emniyeti sağlama ve sallantıyı engelleme
- Kolay sökülüp takılabilme ve demonte hale gelebilme
- Kaymayı önleyen özel tasarımı basamaklar ve platform
- Uzun ömürlü Paslanmaz maksimum mukavemet

## PROFESSIONAL FOLDING SCAFFOLDING

- Special alloyed aluminum ladder
- Easy movement thanks to platform
- With wheels, easy mobility and anchorage
- Thanks to platform cover, easy access to the intended work environment in short time
- Thanks to side bars providing safety and shake prevention
- Easy to assemble and disassemble
- Exclusively designed steps which prevents slipping
- Durable, rust proof, maximum strength



Barkod

Barcode



Kod

Code

İskele  
YüksekliğiScaffolding  
Heightİskele  
GenişliğiScaffolding  
WidthYan  
GenişlikSide  
WidthMax. Platform  
YüksekliğiMax. Platform  
HeightÇalışma  
YüksekliğiWorking  
Height

Ağırlık

Weight

1 Adet m<sup>3</sup>1 Pcs. m<sup>3</sup>

8695849008052

8802-D

2130

800

2020

970

2970

50

0,65

8695849008045

8803-D

3170

800

2020

2100

4100

64

0,95

8699897398127

8804-D

4120

800

2020

2960

4960

78

1,25

PROFAST-L MOBİL METAL İSKELE  
PROFAST-L STEEL SCAFFOLDING



DEMONTÉ HALİ  
DISASSEMBLED STATE

### PROFAST-L MOBİL METAL İSKELE

- Platform sayesinde rahat hareket edebilme
- Tekerler sayesinde rahat hareket edebilme ve sabitleme
- Platform kapak sayesinde kısa sürede istenilen çalışma ortamına ulaşma
- Yan kollar sayesinde emniyeti sağlama ve sallantıyı engelleme
- Kolay sökülüp takılabilmeye ve demonte hale gelebilme
- Kaymayı önleyen özel tasarımı basamaklar ve platform
- Uzun ömürlü Paslanmaz maksimum mukavemet

### PROFAST-L STEEL SCAFFOLDING

- Easy movement thanks to platform
- With wheels, easy mobility and anchorage
- Thanks to platform cover, easy access to the intended work environment in short time
- Thanks to side bars providing safety and shake prevention
- Easy to assemble and disassemble
- Exclusively designed steps which prevents slipping
- Durable, rust proof, maximum strength

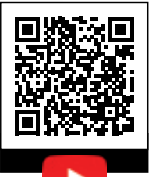

Barkod Barcode	Kod Code	İskele Yüksekliği Scaffolding Height	İskele Genişliği Scaffolding Width	Yan Genişlik Side Width	İskele Modül Boyu Scaffolding Module Length	Platform Ebatları Platform Size	Çalışma Yüksekliği Working Height	Ağırlık Weight	1 Adet m <sup>3</sup> 1 Pcs. m <sup>3</sup>
8695849007550	9804	3000	1150	2500	2000	1000X2500	4200	200	0,75
8695849007543	9806	5000	1150	2500	2000	1000X2500	6200	330	1,20
8695849007536	9808	7000	1150	2500	2000	1000X2500	8200	460	1,65
8695849007529	9810	9000	1150	2500	2000	1000X2500	10200	600	2,10
8695849007512	9812	11000	1150	2500	2000	1000X2500	10200	740	2,70

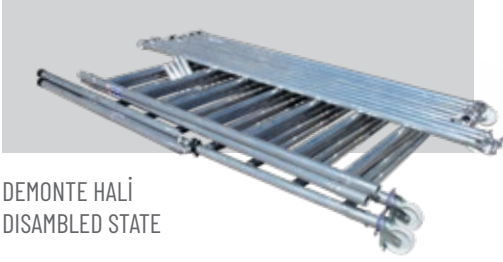
DEMONTE HALİ  
DISASSEMBLED STATE

## PROFAST MOBİL METAL İSKELE

- Platform sayesinde rahat hareket edebilme
- Tekerler sayesinde rahat hareket edebilme ve sabitleme
- Platform kapak sayesinde kısa sürede istenilen çalışma ortamına ulaşma
- Yan kollar sayesinde emniyeti sağlama ve sallantıyı engelleme
- Kolay sökülüp takılabilme ve demonte hale gelebilme
- Kaymayı önleyen özel tasarımı basamaklar ve platform
- Uzun ömürlü Paslanmaz maksimum mukavemet

## PROFAST STEEL SCAFFOLDING

- Easy movement thanks to platform
- With wheels, easy mobility and anchorage
- Thanks to platform cover, easy access to the intended work environment in short time
- Thanks to side bars providing safety and shake prevention
- Easy to assemble and disassemble
- Exclusively designed steps which prevents slipping
- Durable, rust proof, maximum strength

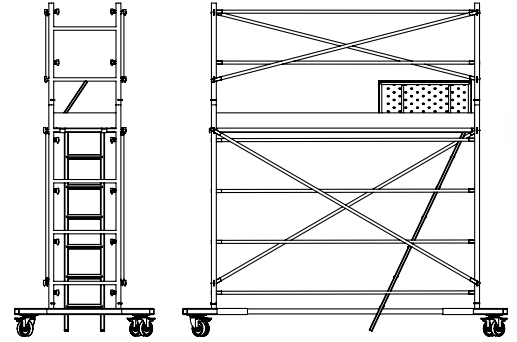

Barkod Barcode	Kod Code	İskele Yüksekliği Scaffolding Height	İskele Genişliği Scaffolding Width	Yan Genişlik Side Width	İskele Modül Boyu Scaffolding Module Length	Platform Ebatları Platform Size	Çalışma Yüksekliği Working Height	Ağırlık Weight	1 Adet m <sup>3</sup> 1 Pcs. m <sup>3</sup>
8695849007505	9804-M	3000	800	2500	2000	600X2500	4200	160	0,75
8695849007499	9806-M	5000	800	2500	2000	600X2500	6200	270	1,20

## ALÜMİNYUM PRATİK İSKELE ALUMINUM PRACTICAL SCAFFOLDING

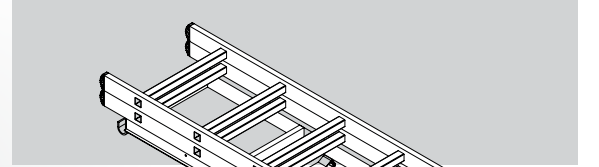

## ALÜMİNYUM PRATİK İSKELE

- Özel alaşımli alüminyum iskele merdiven
- Platform sayesinde rahat hareket edebilme
- Kilit sistemi sayesinde istenilen yükseklikte durma
- Yan kollar sayesinde emniyeti sağlama ve sallantıyı engelleme
- Kolay sökülüp takılabilm ve demonte hale gelebilme
- Kaymayı önleyen özel tasarımı basamaklar ve platform
- Uzun ömürlü Paslanmaz maksimum mukavemet

## ALUMINUM PRACTICAL SCAFFOLDING

- Special alloyed aluminum ladder
- Easy movement via platform
- Adjust the height through the locking device to the requested level
- Thanks to side bars providing safety and shake prevention
- Easy to assemble and disassemble
- Exclusively designed steps which prevents slipping
- Durable, rust proof, maximum strenght

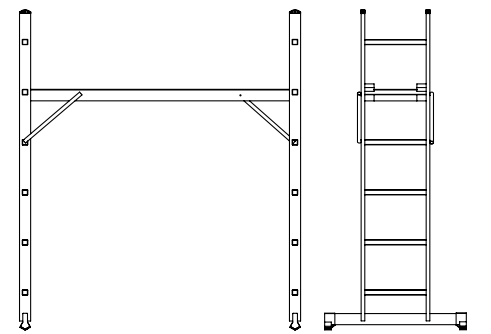

Barkod	Kod	Basamak Sayısı	Max Yükseklik	Merdiven Geniřlięi	Alt Aparat Ölçüsü	Ambalajlı Ölçüleri			Ağırlık	1 Adet m <sup>3</sup>
Barcode	Code	Number of Steps	Max Height	Balance Foot	Lower Kit Size	Package Size			Weight	1 Pcs. m <sup>3</sup>
						a	b	c		
8695849009158	7736	2x6	1500	410	1650	365	62	1980	27,3	0,18

**PLATFORM  
MERDİVEN  
GRUBU**

**PLATFORM  
LADDER  
GROUP**



tam düşündüğünüz gibi | just as you thought



# E-Platform

Kolay parça deęiřtirebilme  
Tam yükseklikte güvenli sürüş  
Yüksek manevra kabiliyeti  
Platformda 220 V priz kablo  
CAN iletişim sistemi

*Easily parts replacibility  
Safe driving at full height  
High maneuverability  
220 V power outlet and cable  
on platform  
CAN communication protocol*



## SARAYLI E-PLATFORM

- Oransal kontrol
- Acil durdurma butonu
- Silindir kontrol valfi
- İz bırakmayan lastikler
- Otomatik çukur koruma
- Hata gösterge ekranı (platform ve yer)
- Acil indirme sistemi
- Uzatma balkonu
- Korna
- Forklift ve vinç ile taşınabilme
- Şarj koruma
- Hareket alarmı
- 2 tekerden sürüş ve kontrol
- Bakım güvenlik aparatı
- Çalışma saati
- Çalışma ikaz lambası
- Eğim sensörü
- Basınç sensörü

## SARAYLI E-PLATFORM

- Proportional control
- Self-lock gate on platform
- Emergency stop button
- Cylinder holding valve
- Non-marking tyre
- Automatic pothole protection
- Onboard diagnostic system (platform and ground control)
- Platform extension
- Horn
- Emergency lowering system
- Liftable with forklift and crane
- Charger protection
- motion alarm
- Control & drive from 2 casters
- Maintenance & safety apparatus
- Hour meter
- Flashing beacon
- Tilt sensor
- Pressure sensor

## TEKNİK ÖZELLİKLER TECHNICAL SPECIFICATIONS

		SR800S	SR800	SR1000S	SR1000	SR1200	SR1400
	Maksimum Çalışma Yüksekliği (m) <i>Max. Working Height</i>	8,00	8,00	10,00	10,00	12,00	13,90
<b>A</b>	Maksimum Platform Yüksekliği (m) <i>Max. Platform Height</i>	5,90	5,90	8,00	8,00	10,00	11,90
<b>B</b>	Kapalı Halde Yükseklik (Korkuluklar Kapalı) (m) <i>Stowed Height (Guardrails off)</i>	1,76	1,62	1,73	1,73	1,83	1,95
<b>C</b>	Kapalı Halde Yükseklik (Korkuluklar Açık) (m) <i>Stowed Height (Guardrails on)</i>	2,32	2,19	2,30	2,30	2,41	2,51
<b>D</b>	Şasenin Yerden Yüksekliği Çukur Koruma Sistemi Açık (m) <i>Chassis Ground Height Pit Protection System Open (m)</i>	0,015	0,020	0,02	0,02	0,02	0,02
<b>E</b>	Şasenin Yerden Yüksekliği Çukur Koruma Sistemi Kapalı (m) <i>Chassis Ground Height Pit Protection System Closed (m)</i>	0,09	0,10	0,10	0,10	0,10	0,10
<b>F</b>	Şase Genişliği (m) <i>Chassis Width</i>	0,79	0,79	0,79	1,15	1,15	1,15
<b>G</b>	Aks Merkez Aralığı (m) <i>Axle - Center Spacing (m)</i>	1,32	1,89	1,89	1,89	1,89	1,89
<b>H</b>	Uzunluk (m) <i>Length</i>	1,65	2,28	2,28	2,28	2,28	2,28
<b>I</b>	Uzunluk (Basamak İle Birlikte) (m) <i>Length (including Access Steps)</i>	1,84	2,49	2,49	2,49	2,49	2,49
<b>J</b>	Platform Genişliği (m) <i>Platform Width</i>	0,79	0,79	0,79	1,15	1,15	1,15
<b>K</b>	Platform Uzunluğu (m) <i>Platform Length</i>	1,64	2,31	2,31	2,31	2,31	2,31
	Platform Uzama (m) <i>Platform Extension</i>	1,00	1,00	1,00	1,00	1,00	1,00
	Mak. Kaldırma Kapasite (kg) <i>Max. Load Capacity of Main Platform</i>	230	300	240	450	300	300
	Mak. Kaldırma Kapasite Uzatma Platform (kg) <i>Max. Capacity of Extension</i>	110	110	110	125	125	125
	Tekerlek <i>Wheel Dimension</i>	12,5x4,25"	12,5x4,5"	15x5"	15x5"	15x5"	15x5"
	Aküler <i>Batteries</i>	4x6V 240Ah					
	Akü Şarj Cihazı <i>Battery Charger</i>	24V/30A					
	Çalışma Eğimi <i>Working Inclination</i>	2°-3°					
	Toplam Ağırlık(Kg) <i>Total Weight</i>	1650	1800	2100	2400	2650	2950

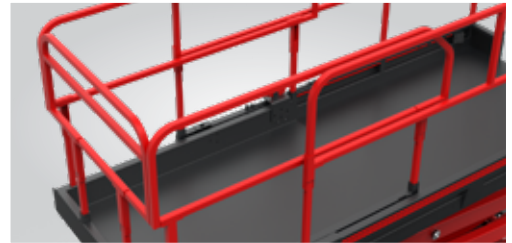
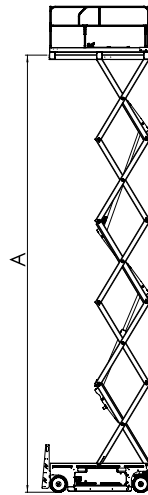
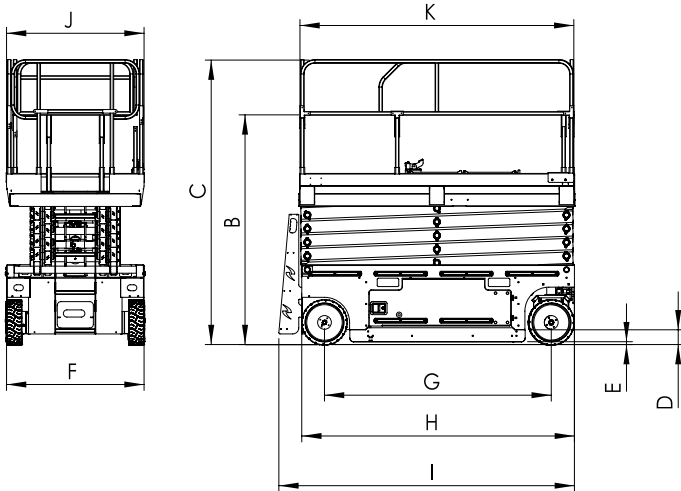

## ALÜMİNYUM KATLANABİLİR TEKERLEKLİ PLATFORM MERDİVEN FOLDABLE WHEELED PLATFORM LADDER



Certificate  
**EN 131-7**  
Norm

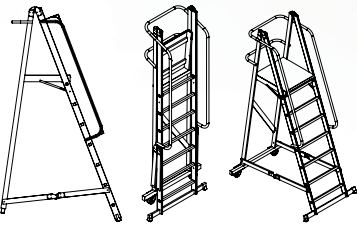
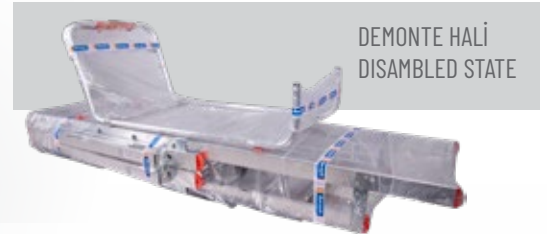
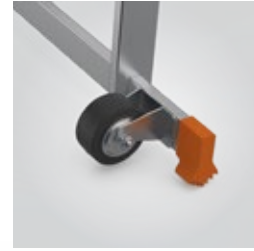

### ALÜMİNYUM KATLANABİLİR TEKERLEKLİ PLATFORM MERDİVEN

- Özel alaşımli alüminyum merdiven
- Kaymayı önleyen özel tasarımı basamaklar
- Endüstriyel amaçlı kullanım
- Güvenli korkuluk sistemi
- Tekerlekler sayesinde kolay hareket edebilme
- Kolay açılıp kapanabilme özelleği
- Güçlendirilmiş ayak desteği
- Bağlantı noktalarında özel kilit
- Uzun ömürlü paslanmaz maksimum mukavemet

### FOLDABLE WHEELED PLATFORM LADDER

- Special alloyed aluminum ladder
- Special designed steps which prevents slipping
- Can be used for Industrial Purpose
- Safety rail system
- Thanks to wheels easy mobility
- Easy to fold
- Fortified leg support
- Special lock on junction
- Durable, rustproof and maximum endurance







Barkod	Kod	Basamak Sayısı	Kapalı Halde Genişlik	Basamak Genişliği	Ürün Boyu	Alt Aparat Genişliği	Platform Yüksekliği	Platform Ebadı	Ağırlık	1 Adet m <sup>3</sup>
Barcode	Code	Number of Steps	Closed Width	Step Width	Product Size	Bottom Bracket Width	Platform Height	Platform Size	Weight	1 Pcs. m <sup>3</sup>
8695849009288	8103	<b>3+1</b>	530	630	2050	1000	1040	570x620	22,0	1,15
8695849008830	8104	<b>4+1</b>	530	630	2350	1000	1320	570x620	23,5	1,25
8695849008823	8105	<b>5+1</b>	530	630	2620	1000	1570	570x620	25,00	1,39
8695849008816	8106	<b>6+1</b>	530	630	2890	1000	1820	570x620	26,50	1,53
8695849008809	8107	<b>7+1</b>	530	630	3160	1000	2070	570x620	28,00	1,67
8695849008793	8108	<b>8+1</b>	530	630	3430	1000	2320	570x620	29,50	1,82

ÇİFT YÖNLÜ KORKULUKLU ENDÜSTRİYEL PLATFORM MERDİVEN  
DOUBLE SIDED RAILED PORTABLED WHEELED PLATFORM LADDER



ÇİFT YÖNLÜ KORKULUKLU  
PLATFORM MERDİVEN

- Özel alaşımli alüminyum merdiven
- Kaymayı önleyen özel tasarımı basamaklar
- Endüstriyel amaçlı kullanım
- Uzun ömürlü paslanmaz maksimum mukavemet
- Güvenli korkuluk sistemi

DOUBLE SIDED RAILED  
PORTABLED WHEELED  
PLATFORM LADDER

- Special alloyed aluminum ladder
- Special designed steps which prevents slipping
- Can be used for Industrial Purpose
- Durable, rustproof and maximum endurance
- Safety rail system

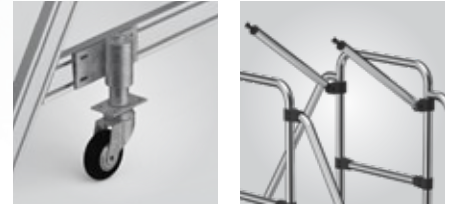

DEMONTÉ HALİ  
DISAMBLÉ STATE

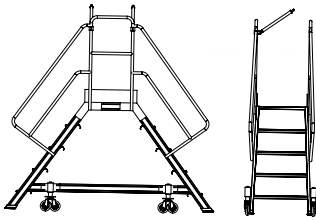

Barkod Barcode	Kod Code	Basamak Sayısı Number of Steps	Basamak Genişliği Step Width	Korkuluk Yüksekliği Railing Height	Yan Dıştan Dışa Genişlik The Outsides of the Side Width	Platform Yüksekliği Platform Height	Platform Ebadı Platform Size	Ağırlık Weight	1 Adet m <sup>3</sup> 1 Pcs. m <sup>3</sup>
8695849008786	8203	3+1	600	1000	2640	750	600x600	40	0,5
8695849008779	8204	4+1	600	1000	2985	1000	600x600	44,5	0,6
8695849008762	8205	5+1	600	1000	3330	1250	600x600	49	0,7
8695849008755	8206	6+1	600	1000	3675	1500	600x600	53,5	0,9
8695849008748	8207	7+1	600	1000	4020	1750	600x600	58	1,0
8695849008731	8208	8+1	600	1000	4365	2000	600x600	62,5	1,1

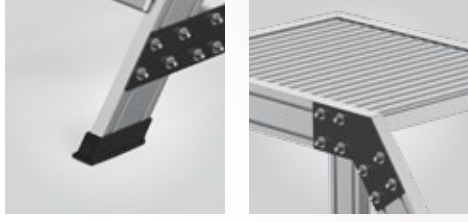

DEMONTE HALİ  
DISAMBLED STATE



## ALÜMİNYUM ÇOK AMAÇLI MONTAJ MERDİVENİ

- Özel alaşımli alüminyum merdiven
- Kaymayı önleyen özel tasarımı basamaklar
- endüstriyel ve konfor amaçlı kullanım
- uzun ömürlü paslanmaz maksimum mukavemet
- geniş platformu sayesinde rahat hareket edebilme

## MULTI PURPOSE MONTAGE LADDER

- Special alloyed aluminum ladder
- Special designed steps which prevents slipping
- Can be used for Industrial Purpose
- Durable, rustproof and maximum endurance
- Safety rail system

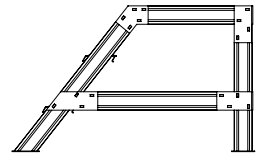
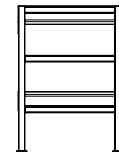

Barkod	Kod	Basamak Sayısı	Basamak Genişliği	Distan Dışa Genişlik	Platform Yüksekliği	Platform Ebadı	Ağırlık	1 Adet m <sup>3</sup>
Barcode	Code	Number of Steps	Step Width	Out-To-Out Width	Platform Height	Platform Size	Weight	1 Pcs. m <sup>3</sup>
8695849008724	8302	2+1	500	1210	750	620x500	20	0,4
8695849008717	8303	3+1	500	1410	1000	620x500	24	0,7
8695849008700	8304	4+1	500	1610	1250	620x500	28	1,0

## ENDÜSTRİYEL TEKERLEKLİ KORKULUKLU ALÜMİNYUM PLATFORM RAILED INDUSTRIAL WHEELED ALUMINIUM PLATFORM LADDERS

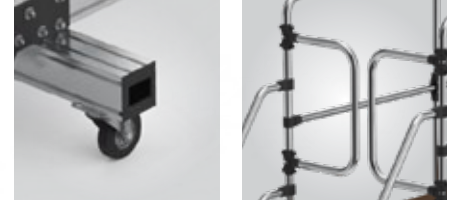

DEMONTE HALİ  
DISAMBLER STATE



### ENDÜSTRİYEL TEKERLEKLİ KORKULUKLU ALÜMİNYUM PLATFORM

- Özel alaşımli alüminyum merdiven
- Kaymayı önleyen özel tasarımı basamaklar
- Endüstriyel amaçlı kullanım
- Uzun ömürlü paslanmaz maksimum mukavemet
- Güvenli korkuluk sistemi
- Tekerlekler sayesinde rahat hareket edebilme ve sabitleme
- Geniş platformu sayesinde rahat hareket edebilme

### RAILED INDUSTRIAL WHEELED ALUMINIUM PLATFORM LADDERS

- Special alloyed aluminum ladder
- Special designed steps which prevents slipping
- Can be used for Industrial Purpose
- Durable, rustproof and maximum endurance
- Safety rail system
- Easy mobility and anchorage thanks to wheels
- Easy movement with its wide platform

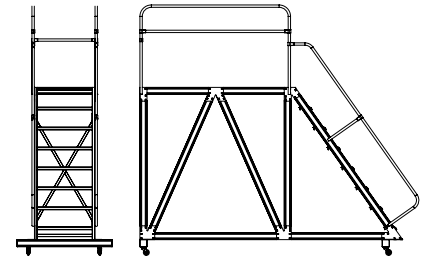

Barkod Barcode	Kod Code	Basamak Sayısı Number of Steps	Basamak Genişliği Step Width	Korkuluk Yüksekliği Railing Height	Alt Kütük Uzunluğu Bottom Bracket Width	Yan Genişlik Side Width	Platform Yüksekliği Platform Height	Platform Ebadı Platform Size	1 Adet m <sup>3</sup> 1 Pcs. m <sup>3</sup>
8695849008694	8404	4+1	760	1000	1200	2820	1250	1970x760	0,8
8695849008687	8405	5+1	760	1000	1200	2995	1500	1970x760	0,9
8695849008670	8406	6+1	760	1000	1200	3170	1750	1970x760	1,1
8695849008663	8407	7+1	760	1000	1200	3345	2000	1970x760	1,2
8695849008656	8408	8+1	760	1000	1200	3520	2250	1970x760	1,4

## ALÜMİNYUM TEK ÇIKIŞLI KORKULUKLU TEKERLEKLİ PLATFORM ADJUSTABLE ONE SIDED RAILED WHEELED PLATFORM



DEMONTED HALİ  
DISASSEMBLED STATE



## ALÜMİNYUM TEK ÇIKIŞLI KORKULUKLU TEKERLEKLİ PLATFORM

- Özel alaşımli alüminyum merdiven
- Kaymayı önleyen özel tasarımlı basamaklar
- Endüstriyel amaçlı kullanım
- Uzun ömürlü paslanmaz maksimum mukavemet
- Güvenli korkuluk sistemi
- Tekerlekler sayesinde kolay hareket edebilme
- Geniş çalışma platformu
- Ayarlanabilir destek aparatı

## ADJUSTABLE ONE SIDED RAILED WHEELED PLATFORM

- Special alloyed aluminum ladder
- Special designed steps which prevents slipping
- Can be used for Industrial Purpose
- Durable, rustproof and maximum endurance
- Safety rail system
- Easy mobility and anchorage thanks to wheels

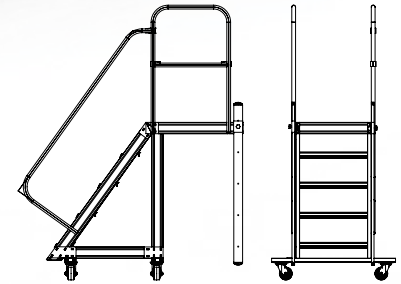

Barkod Barcode	Kod Code	Basamak Sayısı Number of Steps	Basamak Genişliği Step Width	Korkuluk Yüksekliği Railing Height	Alt Kütük Uzunluğu Bottom Bracket Width	Yan Genişlik Side Width	Platform Yüksekliği Platform Height	Platform Ebadı Platform Size	1 Adet m <sup>3</sup> 1 Pcs. m <sup>3</sup>
8695849008649	8503	3+1	600	1100	985	1400	1000	770x600	0,45
8695849008632	8504	4+1	600	1100	985	1575	1250	770x600	0,70
8695849008625	8505	5+1	600	1100	985	1750	1500	770x600	0,90
8695849008618	8506	6+1	600	1100	985	1925	1750	770x600	1,05
8695849008601	8507	7+1	600	1100	985	2100	2000	770x600	1,30
8695849008595	8508	8+1	600	1100	985	2275	2250	770x600	1,40

8703 | 8708

Platform Merdiven Grubu • Platform Ladder Group | [www.smsarayli.com.tr](http://www.smsarayli.com.tr)



Certificate  
**EN 131-7**  
Norm

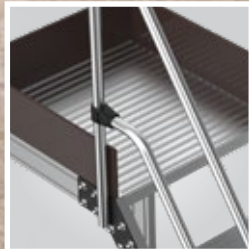

PROFESYONELLİĞİN  
**TAM KARŞILIĞI**

## AYARLANABİLİR AYAKLI TEK ÇIKIŞLI ALÜMİNYUM PLATFORM MERDİVEN ADJUSTABLE ONE SIDED RAILED WHEELED PLATFORM

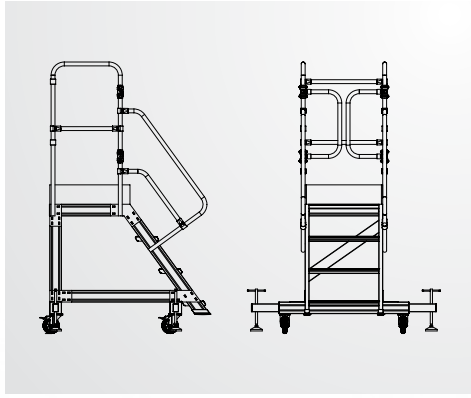

DEMONTE HALİ  
DISAMBLER STATE



### AYARLANABİLİR AYAKLI TEK ÇIKIŞLI ALÜMİNYUM PLATFORM MERDİVEN

- Özel alaşımlı alüminyum merdiven
- Kaymayı önleyen özel tasarımı basamaklar
- Endüstriyel amaçlı kullanım
- Uzun ömürlü Paslanmaz maksimum mukavemet
- Güvenli korkuluk sistemi
- Tekerler ve sabitleme ayaklar sayesinde rahat hareket edebilme ve sabitleme
- Geniş platformu sayesinde rahat hareket edebilme

### ADJUSTABLE ONE SIDED RAILED WHEELED PLATFORM

- Special alloyed aluminum ladder
- Special designed steps which prevents slipping
- Can be used for Industrial Purpose
- Safety rail system
- Thanks to wheels easy mobility
- Easy to fold
- Fortified leg support
- Special lock on junction
- Durable, rustproof and maximum endurance

Barkod Barcode	Kod Code	Basamak Sayısı Number of Steps	Basamak Genişliği Step Width	Korkuluk Yüksekliği Railing Height	Alt Kütük Uzunluğu Bottom Bracket Width	Yan Genişlik Side Width	Platform Yüksekliği Platform Height	Platform Ebadı Platform Size	C Max	Ağırlık Weight	1 Adet m <sup>3</sup> 1 Pcs. m <sup>3</sup>
8695849008519	8703	3+1	600	1100	1000	1200	1000	600x620	1900	45	0,5
8695849008502	8704	4+1	600	1100	1000	1420	1250	600x620	1900	50	0,6
8695849008496	8705	5+1	600	1100	1000	1600	1500	600x620	1900	55	0,75
8695849008489	8706	6+1	600	1100	1000	1780	1750	600x620	1900	60	0,9
8695849008472	8707	7+1	600	1100	1000	1960	2000	600x620	1900	65	1,05
8695849008465	8708	8+1	600	1100	1000	2140	2250	600x620	1900	70	1,2

## ÇİFT YÖNLÜ KORKULUKLU TAŞINABİLİR TEKERLEKLİ PLATFORM MERDİVEN DOUBLE SIDED RAILED PORTABLE WHEELED PLATFORM LADDERS

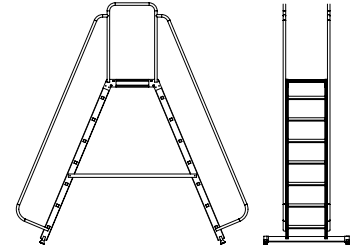
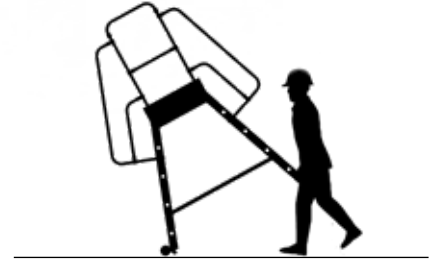

### ÇİFT YÖNLÜ KORKULUKLU TAŞINABİLİR TEKERLEKLİ PLATFORM MERDİVEN

- Özel alaşımli alüminyum merdiven
- Kaymayı önleyen özel tasarımı basamaklar
- Endüstriyel ve konfor amaçlı kullanım
- Uzun ömürlü paslanmaz maksimum mukavemet
- Güvenli korkuluk sistemi ve emniyet şeriti
- Tekerlekler sayesinde kolay hareket edebilme
- Geniş platformu sayesinde rahat hareket edebilme
- Güçlendirilmiş ayak desteği

### DOUBLE SIDED RAILED PORTABLE WHEELED PLATFORM LADDERS

- Special alloyed aluminum ladder
- Special designed steps which prevents slipping
- Can be used for Industrial Purpose
- Durable, rustproof and maximum endurance
- Safety rail system
- Easy mobility and anchorage thanks to wheels
- Easy movement with its wide platform
- Fortified leg support



DEMONTE HALİ  
DISAMBLD STATE

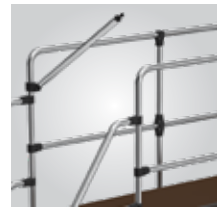

Barkod Barcode	Kod Code	Basamak Sayısı Number of Steps	Basamak Genişliği Step Width	Korkuluk Yüksekliği Railing Height	Alt Kütük Uzunluğu Bottom Bracket Width	Korkuluk Dahil Yan Genişlik Side Sizes Including Rails	Yan Genişlik Side Width	Platform Yüksekliği Platform Height	Platform Ebadı Platform Size	Ağırlık Weight	1 Adet m <sup>3</sup> 1 Pcs. m <sup>3</sup>
8695849008588	8603	3+1	485	1000	1000	1890	1340	945	600x485	24,5	0,6
8695849008571	8604	4+1	485	1000	1000	2100	1550	1200	600x485	29,5	0,7
8695849008564	8605	5+1	485	1000	1000	2310	1760	1455	600x485	34,5	0,8
8695849008557	8606	6+1	485	1000	1000	2520	1970	1710	600x485	39,5	0,9
8695849008540	8607	7+1	485	1000	1000	2730	2180	1965	600x485	44,5	1,0
8695849008533	8608	8+1	485	1000	1000	2940	2390	2220	600x485	49,5	1,1



ALÜMİNYUM ASILABİLİR GENİŞ BASAMAKLI KORKULUKLU ENDÜSTRİYEL MERDİVEN  
ALUMINIUM HANGABLE WIDE STEP RAILED INDUSTRIAL LADDER

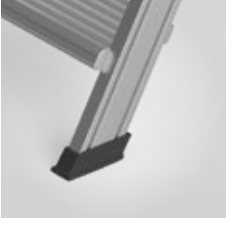
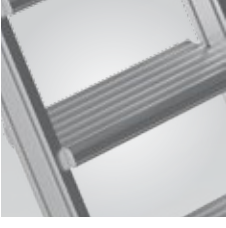

ALÜMİNYUM ASILABİLİR  
GENİŞ BASAMAKLI KORKULUKLU  
ENDÜSTRİYEL MERDİVEN

- Özel alaşımlı alüminyum merdiven
- Kaymayı önleyen özel tasarımı basamaklar
- Endüstriyel amaçlı kullanım
- Uzun ömürlü paslanmaz maksimum mukavemet

ALUMINIUM HANGABLE  
WIDE STEP RAILED  
INDUSTRIAL LADDER

- Special alloyed aluminum ladder
- Special designed steps which prevents slipping
- Can be used for Industrial Purpose
- Durable, rustproof and maximum endurance

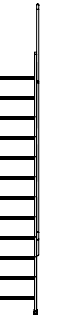
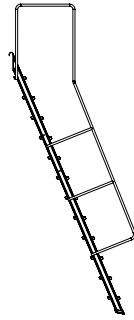

Barkod Barcode	Kod Code	Basamak Sayısı Number of Steps	Basamak Geniřlięi Step Width	Ürün Boyu Product Size	Aęırlık Weight	1 Adet m <sup>3</sup> 1 Pcs. m <sup>3</sup>
8695849008458	7704	4	600	1250	15	0,21
8695849008441	7705	5	600	1500	17,5	0,25
8695849008434	7706	6	600	1750	20	0,29
8695849008427	7707	7	600	2000	22,5	0,33
8695849008410	7708	8	600	2250	25	0,37

ALÜMİNYUM KAFESLİ TÜNEL MERDİVEN  
ALUMINUM CAGE TUNNEL LADDER



ALÜMİNYUM KAFESLİ  
TÜNEL MERDİVEN

- Özel alaşımlı alüminyum merdiven
- Kaymayı önleyen özel tasarımı basamaklar
- Endüstriyel ve konfor amaçlı kullanım
- Uzun ömürlü paslanmaz maksimum mukavemet
- Geniş platformu sayesinde rahat hareket edebilme

ALUMINUM CAGE  
TUNNEL LADDER

- Special alloyed aluminum ladder
- Special designed steps which prevents slipping
- Can be used for Industrial Purpose
- Durable, rustproof and maximum endurance
- Safety rail system



Barkod  
Barcode

8699897397854

8699897397861



Kod  
Code

7918

7927



Basamak Sayısı  
Number of Steps

18

27



Genişlik  
Width

550

550



Merdiven Uzunluğu  
Ladder Length

4940

7410



Korkuluk Uzunluğu  
Cage Length

1000

1000



## PORTATİF ALÜMİNYUM MERDİVEN

- Özel alaşımlı alüminyum merdiven
- Kaymayı önleyen özel tasarımı basamaklar
- Endüstriyel ve konfor amaçlı kullanım
- Uzun ömürlü paslanmaz maksimum mukavemet
- Geniş platformu sayesinde rahat hareket edebilme

## ALUMINIUM STEPLADDER

- Special alloyed aluminum ladder
- Special designed steps which prevents slipping
- Can be used for Industrial Purpose
- Durable, rustproof and maximum endurance
- Safety rail system

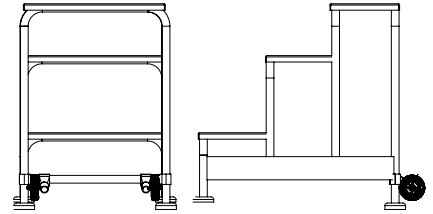

Barkod Barcode	Kod Code	Basamak Sayısı Number of Steps	Basamak Genişliği Step Width	Platform Yüksekliği Step Height	Ürün Ebadı Product Size	Ağırlık Weight	1 Adet m <sup>3</sup> 1 Pcs. m <sup>3</sup>
8695849009318	7802	2	500	500	500x500x500	7	0,1
8695849009301	7803	3	500	750	750x750x750	8,5	0,4
8695849009295	7804	4	500	1000	1000x1000x1000	10	1,0

PORTATİF KORKULUKLU MERDİVEN  
PORTABLE RAIED STEPLADDER

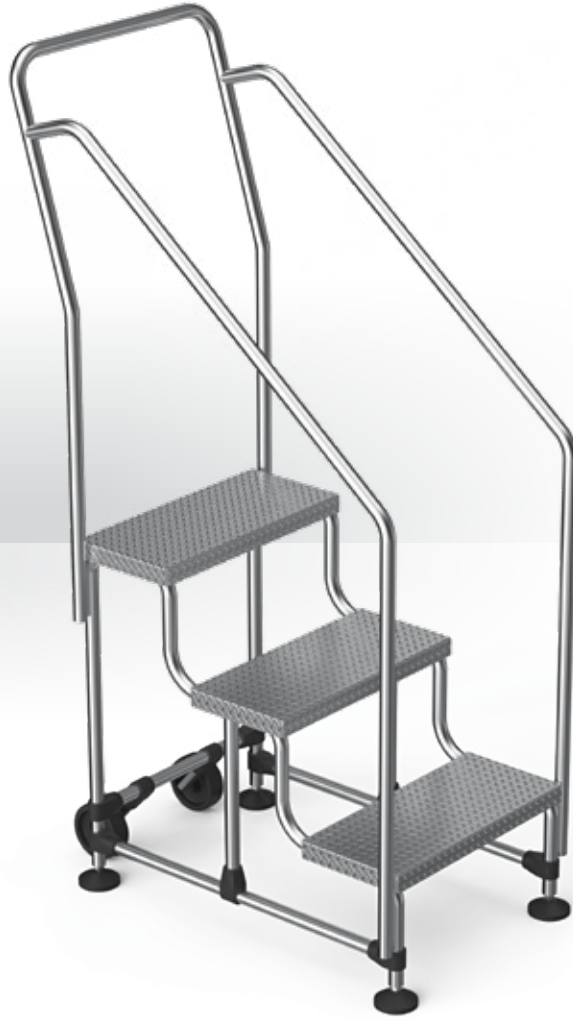

PORTATİF KORKULUKLU  
MERDİVEN

- Özel alaşımli alüminyum merdiven
- Kaymayı önleyen özel tasarımı basamaklar
- Endüstriyel ve konfor amaçlı kullanım
- Uzun ömürlü paslanmaz maksimum mukavemet
- Geniş platformu sayesinde rahat hareket edebilme

PORTABLE RAIED  
STEPLADDER

- Special alloyed aluminum ladder
- Special designed steps which prevents slipping
- Can be used for Industrial Purpose
- Durable, rustproof and maximum endurance
- Safety rail system

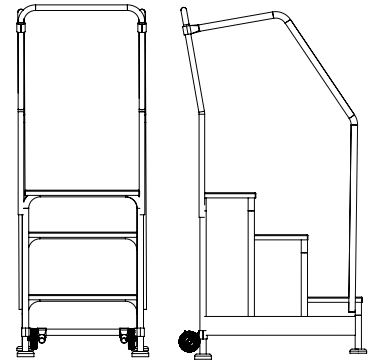

Barkod Barcode	Kod Code	Basamak Sayısı Number of Steps	Basamak Genişliği Step Width	Platform Yüksekliği Step Height	Ürün Ebadı Product Size	Ağırlık Weight	1 Adet m <sup>3</sup> 1 Pcs. m <sup>3</sup>
8695849008274	7812	2	500	500	1500x500x500	10	0,1
8695849008267	7813	3	500	750	1750x750x750	11,5	0,4
8695849008250	7814	4	500	1000	2000x1000x1000	13	1,0

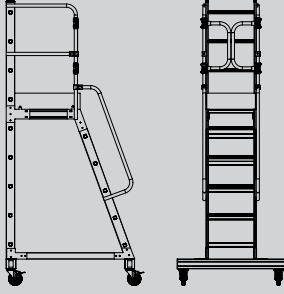
Certificate  
**EN 131-7**  
NormDEMONTE HALİ  
DISASSEMBLED STATE

## ALÜMİNYUM RAF MERDİVENİ

- Özel alaşımlı alüminyum merdiven
- Kaymayı önleyen özel tasarımı basamaklar
- Endüstriyel amaçlı kullanım
- Uzun ömürlü paslanmaz maksimum mukavemet
- Güvenli korkuluk sistemi
- Tekerler ve sabitleme ayaklar sayesinde rahat hareket edebilme ve sabitleme
- Geniş platformu sayesinde rahat hareket edebilme

## ALUMINIUM SHELF LADDER

- Special alloyed aluminum ladder
- Special designed steps which prevents slipping
- Can be used for Industrial Purpose
- Durable, rustproof and maximum endurance
- Safety rail system and safety rope
- Easy mobility and anchorage thanks to wheels
- Easy movement with its wide platform



Barkod

Barcode



Kod

Code



Basamak

Sayısı  
Number of  
StepsBasamak  
Genişliği  
Step WidthÜrün  
Boy  
Products  
SizeAlt Aparat  
Genişliği  
Bottom Apparatus  
HeightPlatform  
Yüksekliği  
Platform  
HeightPlatform  
Ebadı  
Platform  
Size

Ağırlık

Weight

1 Adet m<sup>3</sup>1 Pcs. m<sup>3</sup>

8695849007482

7825

5+1

460

1000

1000

1500

600x460

30

0,63

8695849007475

7827

7+1

460

1000

1000

2000

600x460

33

0,75

8695849007468

7829

9+1

460

1000

1000

2500

600x460

36

0,87

## ÇİFT SÜRGÜLÜ KATLANABİLİR TEKERLEKLİ PLATFORM MERDİVEN DOUBLE-SIDED FOLDABLE WHEELED PLATFORM LADDER (SLIDING TYPE)

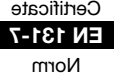

DEMONTÉ HALİ  
DISASSEMBLED STATE

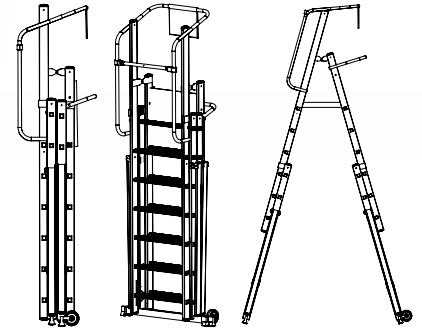

## ÇİFT SÜRGÜLÜ KATLANABİLİR TEKERLEKLİ PLATFORM MERDİVEN

- Özel alaşımli alüminyum merdiven
- Kaymayı önleyen özel tasarımı basamaklar
- Endüstriyel amaçlı kullanım
- Güvenli korkuluk sistemi
- Tekerlekler sayesinde kolay hareket edebilme
- Kolay açılıp kapanabilme özelleği
- Güçlendirilmiş ayak desteği
- Bağlantı noktalarında özel kilit
- Uzun ömürlü paslanmaz maksimum mukavemet

## DOUBLE-SIDED FOLDABLE WHEELED PLATFORM LADDER(SLIDING TYPE)

- Special alloyed aluminum ladder
- Special designed steps which prevents slipping
- Can be used for Industrial Purpose
- Safety rail system
- Thanks to wheels easy mobility
- Easy to fold
- Fortified leg support
- Special lock on junction
- Durable, rustproof and maximum endurance



Barkod	Kod	Basamak Sayısı	Kapalı Halde Genişlik	Basamak Genişliği	Ürün Boyu	Alt Aparat Genişliği	Platform Yüksekliği	Platform Ebadı	Ağırlık	1 Adet m <sup>3</sup>
Barcode	Code	Number of Steps	Closed Width	Step Width	Product Size	Bottom Bracket Width	Platform Height	Platform Size	Weight	1 Pcs. m <sup>3</sup>
8695849009288	8104-Ç	8+9	530	630	2400	1000	1320-1850	570x620	48	1,25
8695849008298	8105-Ç	10+11	530	630	2650	1000	1570-2400	570x620	50	1,45
8695849008281	8106-Ç	12+13	530	630	2900	1000	1820-2820	570x620	52	1,65

Certificate  
EN 131-7  
Norm



ALÜMİNYUM YAYLI AYAKLI TEK ÇIKIŞLI PLATFORM MERDİVEN  
ONE-SIDED WHEELED PLATFORM LADDER (SPRING-LOADED TYPE)

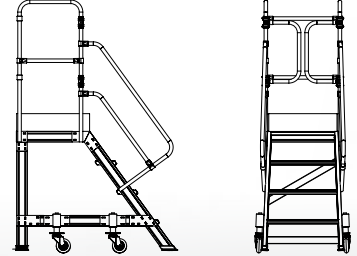

ALÜMİNYUM  
YAYLI AYAKLI TEK ÇIKIŞLI  
PLATFORM MERDİVEN

- Özel alaşımli alüminyum merdiven
- Kaymayı önleyen özel tasarımı basamaklar
- Endüstriyel amaçlı kullanım
- Güvenli korkuluk sistemi
- Tekerlekler sayesinde kolay hareket edebilme
- Kolay açılıp kapanabilme özelleği
- Güçlendirilmiş ayak desteği
- Bağlantı noktalarında özel kilit
- Uzun ömürlü paslanmaz maksimum mukavemet

ONE-SIDED WHEELED  
PLATFORM LADDER  
(SPRING-LOADED TYPE)

- Special alloyed aluminum ladder
- Special designed steps which prevents slipping
- Can be used for Industrial Purpose
- Safety rail system
- Thanks to wheels easy mobility
- Easy to fold
- Fortified leg support
- Special lock on junction
- Durable, rustproof and maximum endurance

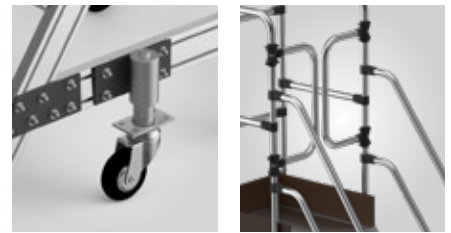

Barkod Barcode	Kod Code	Basamak Sayısı Number of Steps	Basamak Geniřliđi Step Width	Korkuluk Yüksekliđi Railing Height	Yan Geniřlik Side Width	Platform Yüksekliđi Platform Height	Platform Ebadı Platform Size	Ađırlık Weight	1 Adet m <sup>3</sup> 1 Pcs. m <sup>3</sup>
8695849009271	8702-Y	2+1	600	1100	1000	750	600x620	37	0,3
8695849008335	8703-Y	3+1	600	1100	1200	1000	600x620	42	0,5
8695849008328	8704-Y	4+1	600	1110	1420	1250	600x620	47	0,6
8695849008311	8705-Y	5+1	600	1110	1600	1500	600x620	52	0,8
8695849008304	8706-Y	6+1	600	1100	1780	1750	600x620	57	0,9

ALÜMİNYUM SÜRGÜLÜ BAKIM ONARIM MERDİVENİ  
PROFESSIONAL SLIDING MAINTENANCE AND REPAIR LADDER



ALÜMİNYUM SÜRGÜLÜ  
BAKIM ONARIM MERDİVENİ

- Özel alaşımli alüminyum merdiven
- Kaymayı önleyen özel tasarımı basamaklar
- Endüstriyel amaçlı kullanım
- Uzun ömürlü paslanmaz maksimum mukavemet
- Güvenli korkuluk sistemi
- Tekerler ve sabitleme ayaklar sayesinde rahat hareket edebilme ve sabitleme
- Geniş platformu sayesinde rahat hareket edebilme
- Sürgülü sistemi sayesinde istediğiniz yüksekliğe rahatça erişebilme

PROFESSIONAL SLIDING  
MAINTENANCE AND REPAIR LADDER

- Special alloyed aluminum ladder
- Special designed steps which prevents slipping
- Can be used for Industrial Purpose
- Durable, rustproof and maximum endurance
- Safety rail system and safety tape
- Easy mobility and anchorage thanks to wheels
- Easy movement with its wide platform
- Easy access to wanted height thanks to its sliding system

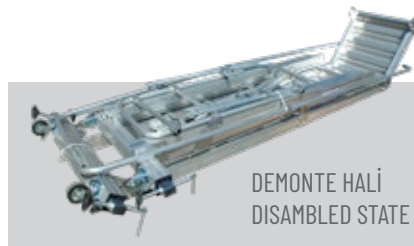

DEMONTE HALİ  
DISAMBLED STATE

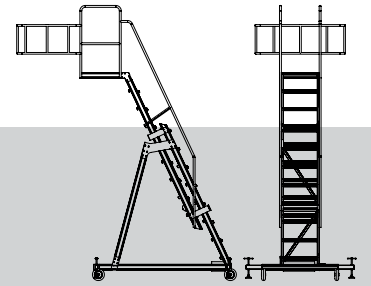

Barkod	Kod	Basamak Sayısı	Basamak Genişliği	1. Kademe Yükseklik	1. Kademe Yükseklik	Alt Kütük Uzunluğu	Platform Ebadı	Ürün Genişliği
Barcode	Code	Number of Steps	Step Width	First Stage Height	Secondary Elevation	Lower Billet Length	Platform Size	Product Width
8695849008212	7844	4+5	540	2500	3250	1000-1900	600x750	2000
8695849008205	7846	6+7	540	3000	4350	1000-1900	600x750	2200
8695849008199	7848	8+9	540	4000	5900	1200-2100	600x750	3500



**EV TİPİ  
MERDİVEN  
GRUBU**

**HOME TYPE  
LADDER  
GRUP**



tam düşündüğünüz gibi | just as you thought

SARAYLI ALÜMİNYUM PROFESYONEL MERDİVEN  
ALUMINUM PROFESSIONAL LADDERCertificate  
EN 131  
NormSARAYLI ALÜMİNYUM  
PROFESYONEL  
MERDİVEN

- İlave tabla basamağı
- Özel alaşımli alüminyum merdiven
- Kolay açılıp kapanabilme
- Kullanıma hazır tek şıklı ambalaj
- Çizilmeyi önleyen plastik takozlar
- Kaymayı önleyen özel tasarımı basamaklar
- Ev ve işyerlerinde dekoratif kullanım
- Çok hafif ve yük taşımada kuvvetli
- Uzun ömürlü Paslanmaz maksimum mukavemet

SARAYLI ALUMINUM  
PROFESSIONAL  
LADDER

- Additional top step
- Special alloyed aluminum ladder
- Easy to fold away
- Ready to use stylish single pack
- Exclusively designed steps which prevents slipping
- Plastic wedges which prevents scuffing
- Decorative usage for both home and industrial use
- Very light weight and high resistance to heavy loading
- Durable, rustproof and maximum endurance

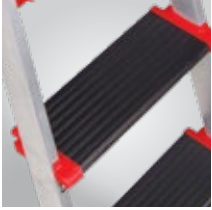
Barkod  
Barcode8699897397793  
8699897397809  
8699897397816  
8699897397823  
8699897397830Kod  
Code1302  
1303  
1304  
1305  
1306Basamak Sayısı  
Number of Steps2+1  
3+1  
4+1  
5+1  
6+1Ambalajlı Ölçüleri  
Packed Size

a	b	c
1500	470	130
1780	495	130
2060	520	130
2330	545	130
2620	575	130

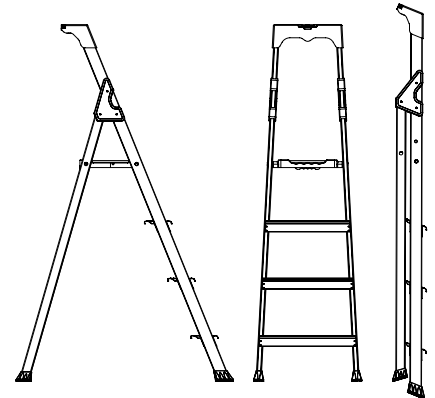
Ağırlık  
Weight5,3  
6,36  
7,5  
8,6  
9,53

SARAYLI ALÜMİNYUM MERDİVEN  
ALUMINUM LADDER

Certificate  
EN 131  
Norm



**150** kg  
TAŞIMA KAPASİTESİ  
BEARING CAPACITY

SARAYLI ALÜMİNYUM  
MERDİVEN

- İlave tabla basamağı
- Özel alaşımli alüminyum merdiven
- Kolay açılıp kapanabilme
- Kullanıma hazır tek şıklı ambalaj
- Çizilmeyi önleyen plastik takozlar
- Kaymayı önleyen özel tasarımlı basamaklar
- Ev ve işyerlerinde dekoratif kullanım
- Çok hafif ve yük taşımada kuvvetli
- Uzun ömürlü Paslanmaz maksimum mukavemet

ALUMINUM  
LADDER

- Additional top step
- Special alloyed aluminum ladder
- Easy to fold away
- Ready to use stylish single pack
- Exclusively designed steps which prevents slipping
- Plastic wedges which prevents scuffing
- Decorative usage for both home and industrial use
- Very light weight and high resistance to heavy loading
- Durable, rustproof and maximum endurance

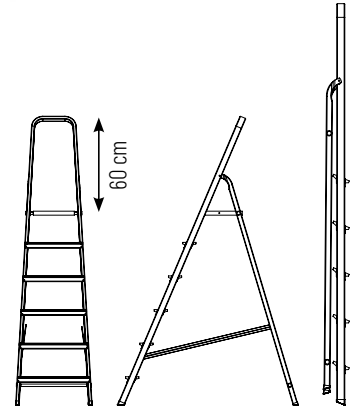

Barkod  
Barcode



Kod  
Code



Basamak Sayısı  
Number of Steps



Ürün Ebadı  
Product Size



Ambalajlı Ölçüleri  
Packed Size



Ağırlık  
Weight



1 Adet m<sup>3</sup>  
1 Pcs. m<sup>3</sup>

8695849001473

1501

2+1

a

b

c

a

b

c

3,90

0,052

8695849001480

1502

3+1

435

850

1415

435

110

1535

4,40

0,062

8695849001497

1503

4+1

460

1010

1625

460

110

1765

5,10

0,076

8695849001503

1504

5+1

485

1160

1840

485

110

1995

5,70

0,085

8695849001510

1505

6+1

510

1290

2055

510

110

2235

6,60

0,099

8695849002197

1506

7+1

535

1415

2280

535

110

2465

7,20

0,114

## SARAYLI ALÜMİNYUM ÇİFT TARAFLI MERDİVEN

### DOUBLE-SIDED ALUMINUM LADDER



Certificate  
**EN 131**  
Norm

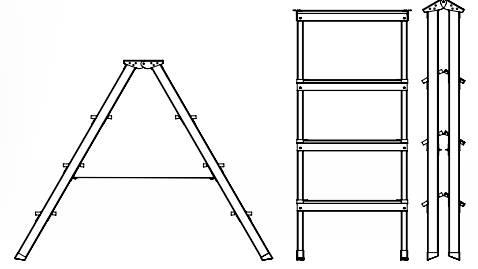
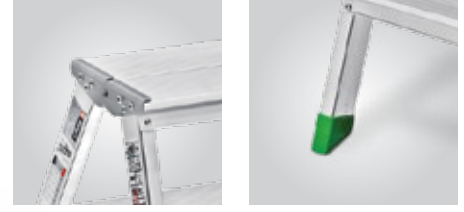

## SARAYLI ALÜMİNYUM ÇİFT TARAFLI MERDİVEN

- Özel alaşımli alüminyum merdiven
- Kolay açılıp kapanabilme
- Çift taraflı çıkış ve kullanabilme
- Kullanıma hazır tek şıklı ambalaj
- Çizilmeyi önleyen plastik takozlar
- Kaymayı önleyen özel tasarımı basamaklar
- Ev ve işyerlerinde dekoratif kullanım
- Çok hafif ve yük taşımada kuvvetli
- Uzun ömürlü Paslanmaz maksimum mukavemet

## DOUBLE-SIDED ALUMINUM LADDER

- Special alloyed aluminum ladder
- Easy to fold away
- Easy to climb and use from both sides
- Ready to use stylish single pack
- Plastic wedges which prevents scuffing
- Exclusively designed steps which prevents slipping
- Decorative usage for both home and industrial use
- Very light weight and high resistance to heavy loading
- Durable, rustproof and maximum endurance



Barkod  
Barcode

8695849009219

8695849009202

8695849009196

8695849009189

8695849009172

8695849009165

8695849008847



Kod  
Code

1802

1803

1804

1805

1806

1807

1808



Basamak Sayısı  
Number of Steps

**2+2**

**3+3**

**4+4**

**5+5**

**6+6**

**7+7**

**8+8**



Ürün Ebadı  
Product Size

a

b

c

390

460

400

410

625

620

440

815

825

460

1020

1035

485

1185

1260

510

1345

1475

540

1460

1680



Ambalajlı Ölçüleri  
Packed Size

a

b

c

395

165

465

415

165

690

445

165

865

465

165

1160

490

165

1390

515

165

1620

515

165

1850



Ağırlık  
Weight

1,70

2,60

3,70

4,50

5,20

6,40

7,30



1 Adet m<sup>3</sup>  
1 Pcs. m<sup>3</sup>

0,03

0,05

0,07

0,09

0,12

0,14

0,16



## SARAYLI ALÜMİNYUM MEGA ÇİFT TARAFLI MERDİVEN

- Özel alaşımli alüminyum merdiven
- Kolay açılıp kapanabilme
- Çift taraflı çıkış ve kullanabilme
- Kullanıma hazır tek şıklı ambalaj
- Çizilmeyi önleyen plastik takozlar
- Kaymayı önleyen özel tasarımı basamaklar
- Ev ve işyerlerinde dekoratif kullanım
- Çok hafif ve yük taşımada kuvvetli
- Uzun ömürlü Paslanmaz maksimum mukavemet

## ALUMINUM MEGA LADDER

- Special alloyed aluminum ladder
- Easy to fold away
- Easy to climb and use from both sides
- Ready to use stylish single pack
- Plastic wedges which prevents scuffing
- Exclusively designed steps which prevents slipping
- Decorative usage for both home and industrial use
- Very light weight and high resistance to heavy loading
- Durable, rustproof and maximum endurance

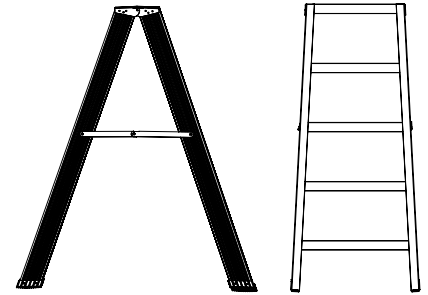

Barkod  
Barcode

8695849009660

8695849001015

8695849001039

8695849002128

8695849002012

8693609131903

8695849009653



Kod  
Code

1902

1903

1904

1905

1906

1907

1908



Basamak Sayısı  
Number of Steps

2+2

3+3

4+4

5+5

6+6

7+7

8+8



Ürün Ebadı  
Product Size

a

b

c

495

435

470

645

465

710

505

790

925

545

935

1145

575

1095

1360

605

1255

1575

635

1385

1765



Ambalajlı Ölçüleri  
Packed Size

a

b

c

165

410

505

165

430

785

165

450

870

165

470

1164

165

495

1400

165

616

1720

165

633

1890



Ağırlık  
Weight

2,50

3,55

4,65

5,75

6,85

7,95

9,70



1 Adet m<sup>3</sup>  
1 Pcs. m<sup>3</sup>

0,03

0,05

0,06

0,09

0,11

0,14

0,16

SARAYLI JACKSON MERDİVEN  
JACKSON LADDERSARAYLI JACKSON  
MERDİVEN

- İlave tabla basamağı
- Profil üzeri galvaniz kaplama
- Kolay açılıp kapanabilme
- Kullanıma hazır tek şıklı ambalaj
- Çizilmeyi önleyen plastik takozlar
- Kaymayı önleyen özel tasarımı basamaklar
- Ev ve işyerlerinde dekoratif kullanım

JACKSON  
LADDER

- Additional top step
- Galvanize covering over profile
- Easy to fold away
- Ready to use stylish single pack
- Plastic wedges which prevents scuffing
- Exclusively designed steps which prevents slipping
- Decorative usage for both home and industrial use

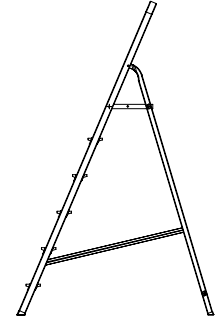

Barkod Barcode	Kod Code	Basamak Sayısı Number of Steps	Ürün Ebadı Product Size			Ambalajlı Ölçüleri Packed Size			Ağırlık Weight	1 Adet m <sup>3</sup> 1 Pcs. m <sup>3</sup>
			a	b	c	a	b	c		
8695849001558	1101	2+1	400	645	1080	400	105	1170	4,30	0,045
8695849001565	1102	3+1	425	820	1300	425	105	1400	5,60	0,055
8695849001572	1103	4+1	460	965	1520	460	105	1640	6,50	0,070
8695849001589	1104	5+1	490	1120	1760	490	105	1890	7,50	0,080
8695849001596	1105	6+1	520	1290	1980	520	105	2140	8,60	0,091
8695849001602	1106	7+1	555	1425	2230	555	105	2390	9,30	0,110
8695849001619	1107	8+1	585	1615	2470	585	105	2640	11,20	0,125
8695849001626	1108	9+1	615	1750	2710	615	105	2890	12,50	0,140

## SARAYLI METAL ÇİFT ÇIKIŞLI MERDİVEN

- Özel alaşımlı alüminyum merdiven
- Kolay açılıp kapanabilme
- Çift taraflı çıkış ve kullanabilme
- Kullanıma hazır tek şıklı ambalaj
- Çizilmeyi önleyen plastik takozlar
- Kaymayı önleyen özel tasarımı basamaklar
- Ev ve işyerlerinde dekoratif kullanım
- Çok hafif ve yük taşımada kuvvetli
- Uzun ömürlü Paslanmaz maksimum mukavemet

## DOUBLE SIDED STEEL LADDER

- Special alloyed aluminum ladder
- Easy to fold away
- Easy to climb and use from both sides
- Ready to use stylish single pack
- Plastic wedges which prevents scuffing
- Exclusively designed steps which prevents slipping
- Decorative usage for both home and industrial use
- Very light weight and high resistance to heavy loading
- Durable, rustproof and maximum endurance

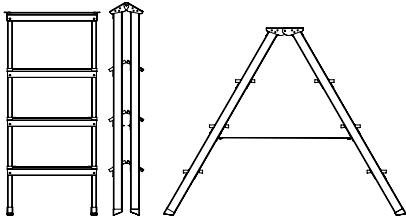

Barkod Barcode	Kod Code	Basamak Sayısı Number of Steps	Ürün Ebadı Product Size			Ambalajlı Ölçüleri Packed Size			Ağırlık Weight	1 Adet m <sup>3</sup> 1 Pcs. m <sup>3</sup>
			a	b	c	a	b	c		
8695849007802	1202	<b>2+2</b>	400	360	390	400	165	450	2,65	0,03
8695849007796	1203	<b>3+3</b>	430	480	790	430	165	680	4,00	0,048
8695849007789	1204	<b>4+4</b>	460	600	840	460	165	900	5,40	0,068
8695849007772	1205	<b>5+5</b>	490	720	1080	490	165	1140	6,90	0,092
8695849007765	1206	<b>6+6</b>	520	840	1350	520	165	1410	8,60	0,121
8695849007758	1207	<b>7+7</b>	550	960	1590	550	165	1650	10,50	0,15
8695849007741	1208	<b>8+8</b>	580	1080	1830	580	165	1890	12,20	0,18
8695849007734	1209	<b>9+9</b>	610	1200	2060	610	165	2120	14,1	0,213

SARAYLI A TİPİ AHŞAP MERDİVEN  
WOODEN LADDERSARAYLI A TİPİ  
AHŞAP MERDİVEN

- Kalite gürgen ağacından imal edilmiştir.
- Isıl işlem görmüştür, eğilme bükülme karşı dirençlidir.
- Isıl işlem sonrası vernik ile kaplanmıştır
- Kolay açılıp kapanabilme
- Çift taraflı çıkış ve kullanabilme
- Kullanıma hazır tekli şık ambalaj
- Ev ve işyerlerinde dekoratif kullanım
- Elektriksi iletmez

## WOODEN LADDER

- Additional top step
- Special alloyed aluminum ladder
- Easy to fold away
- Ready to use stylish single pack
- Exclusively designed steps which prevents slipping
- Plastic wedges which prevents scuffing
- Decorative usage for both home and industrial use
- Very light weight and high resistance to heavy loading
- Durable, rustproof and maximum endurance

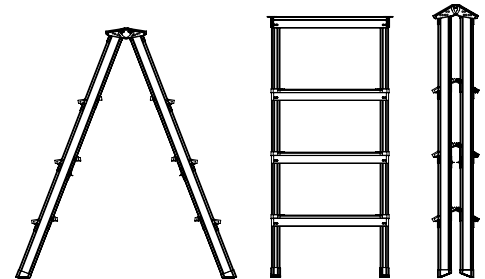
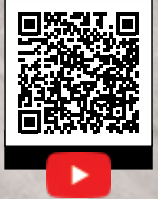
Barkod  
Barcode8695849009981  
8695849009967  
8695849009943  
8695849009929  
8695849009769Kod  
Code1403  
1404  
1405  
1406  
1407Basamak Sayısı  
Number of Steps3+3  
4+4  
5+5  
6+6  
7+7Ürün Ebadı  
Product Size

a	b	c
730	420	900
810	460	1200
1020	500	1470
1160	540	1760
1330	580	2040

Ambalajlı Ölçüleri  
Packed Size

a	b	c
420	100	960
460	100	1260
500	100	1550
540	100	1850
580	100	2140

Ağırlık  
Weight4,90  
6,20  
7,60  
9,50  
11,301 Adet m<sup>3</sup>  
1 Pcs. m<sup>3</sup>0,04  
0,057  
0,070  
0,099  
0,124





## SARAYLI TABURELİ MerdİVEN

- Elektrostatik fırınlanmış boyalı metal aksamlar
- Kolay açılıp kapanabilme
- Kullanıma hazır tek şıklı ambalaj
- Kaymayı önleyen plastik ayak takozları
- Kaymayı önleyen özel tasarımlı basamaklar
- Ev ve işyerlerinde dekoratif kullanım

## SARAYLI STOOL LADDER

- Elektrostatik fırınlanmış boyalı metal aksamlar
- Kolay açılıp kapanabilme
- Kullanıma hazır tek şıklı ambalaj
- Kaymayı önleyen plastik ayak takozları
- Kaymayı önleyen özel tasarımlı basamaklar
- Ev ve işyerlerinde dekoratif kullanım



Barkod  
Barcode

8699897397564



Kod  
Code

1151



Basamak Sayısı  
Number of Steps

2+1



Ürün Ebadı  
Product Size

a	b	c
620	360	680



Ambalajlı Ölçüleri  
Packed Size

a	b	c
330	370	700



Ağırlık  
Weight

5,6



1 Adet m<sup>3</sup>  
1 Pcs. m<sup>3</sup>

0,085

PRATİK MEGA METAL MERDİVEN  
PRACTICAL STEEL MEGA LADDER



PRATİK MEGA  
METAL MERDİVEN

- Elektrostatik fırınlanmış boyalı metal aksesuarlar
- Kolay açılıp kapanabilme
- Kullanıma hazır tekli şık ambalaj
- Kaymayı önleyen plastik ayak takozlar
- Kaymayı önleyen özel tasarımlı basamaklar
- Ev ve işyerlerinde dekoratif kullanım
- Güvenlik kilitle
- Plastik Kaplı Tutma Yeri

PRACTICAL STEEL  
MEGA LADDER

- Electrostatically dyed metal accessories
- Practical folding away
- Ready to use in stylish single pack
- Plastic wedges which prevents slipping
- Exclusively designed steps which prevents slipping
- Decorative usage for both home and industrial use
- With safety lock
- Handle covered with polyurethane

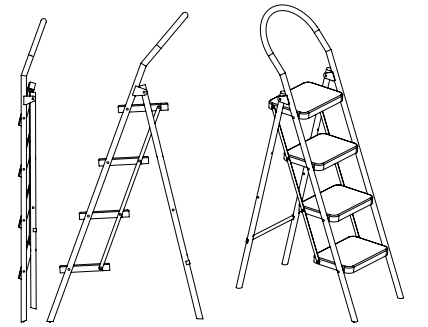

Barkod Barcode	Kod Code	Basamak Sayısı Number of Steps	Ürün Ebadı Product Size			Ambalajlı Ölçüleri Packed Size			Ağırlık Weight	1 Adet m <sup>3</sup> 1 Pcs. m <sup>3</sup>
			a	b	c	a	b	c	KG	
8695849008861	1642	2	550	430	830	75	430	950	3,68	0,031
8695849008878	1643	3	740	430	1090	75	430	1210	5,00	0,039
8695849008892	1644	4	930	430	1350	75	430	1470	6,20	0,047



## PRATİK LÜKS MEGA METAL MERDİVEN

- Elektrostatik fırınlanmış boyalı metal aksamlar
- Kolay açılıp kapanabilme
- Kullanıma hazır tekli şık ambalaj
- Kaymayı önleyen plastik ayak takozlar
- Kaymayı önleyen özel tasarımlı basamaklar
- Ev ve işyerlerinde dekoratif kullanım
- Güvenlik kilitle
- Plastik Kaplı Tutma Yeri
- Geniş basamak

## PRACTICAL STEEL MEGA LUX LADDER

- Electrostatically dyed metal accessories
- Practical folding away
- Ready to use in stylish single pack
- Plastic wedges which prevents slipping
- Exclusively designed steps which prevents slipping
- Decorative usage for both home and industrial use
- With safety lock
- Handle covered with polyurethane
- Wide steps

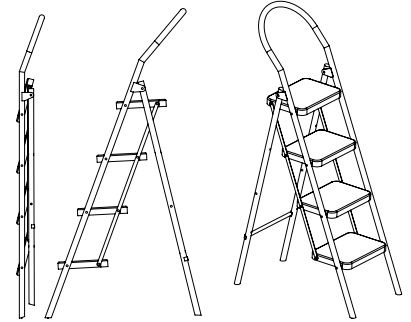

Barkod Barcode	Kod Code	Basamak Sayısı Number of Steps	Ürün Ebadı Product Size			Ambalajlı Ölçüleri Packed Size			Ağırlık Weight	1 Adet m <sup>3</sup> 1 Pcs. m <sup>3</sup>
			a	b	c	a	b	c		
8695849009523	1612	2	550	500	850	75	470	980	5,10	0,035
8695849009530	1613	3	700	500	1135	75	470	1280	7,00	0,045
8695849009547	1614	4	850	500	1400	75	520	1550	9,10	0,060
8699897397786	1615	5	1000	500	1700	75	520	1880	10,60	0,070

## SARAYLI PRATİK METAL MERDİVEN PRACTICAL STEEL LADDER

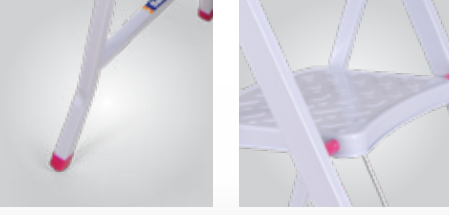

## SARAYLI PRATİK METAL MERDİVEN

- Elektrostatik fırınlanmış boyalı metal aksamlar
- Kolay açılıp kapanabilme
- Kullanıma hazır tekli şık ambalaj
- Kaymayı önleyen plastik ayak takozlar
- Kaymayı önleyen özel tasarımlı basamaklar
- Ev ve işyerlerinde dekoratif kullanım
- Güvenlik kilitli

## PRACTICAL STEEL LADDER

- Electrostatically dyed metal accessories
- Practical folding away
- Ready to use in stylish single pack
- Plastic wedges which prevents slipping
- Exclusively designed steps which prevents slipping
- Decorative usage for both home and industrial use
- Safety lock



Barkod  
Barcode

8695849009554  
8695849009561  
8695849009578



Kod  
Code

1632  
1633  
1634



Basamak Sayısı  
Number of Steps

2  
3  
4



Ürün Ebadı  
Product Size

a	b	c
560	460	820
720	460	1050
830	460	1300



Ambalajlı Ölçüleri  
Packed Size

a	b	c
70	465	900
70	465	1160
70	465	1410



Ağırlık  
Weight

3,90  
5,50  
7,15



1 Adet m<sup>3</sup>  
1 Pcs. m<sup>3</sup>

0,029  
0,038  
0,046

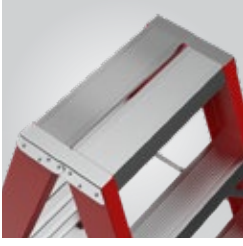

## FİBER MEGA MERDİVEN

- Elektrik yalıtımlı merdiven
- Kolay açılıp kapanabilme
- Çift taraflı çıkış ve kullanabilme
- Kullanıma hazır tek şıklı ambalaj
- Kaymayı önleyen özel tasarımlı basamaklar
- Uzun ömürlü Paslanmaz maksimum mukavemet

## FIBER MEGA LADDER

- Electrically insulated ladder
- Easy to open and close
- Double-sided output and use
- Single stylish packaging ready to use
- Specially designed steps that prevent slipping
- Long-lasting stainless steel maximum strength

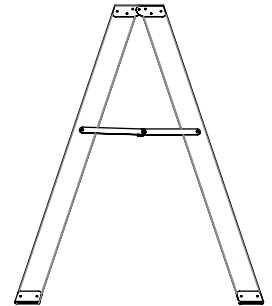
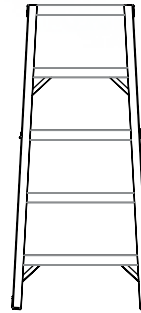

Barkod  
Barcode



Kod  
Code



Basamak Sayısı  
Number of Steps



Ürün Ebadı  
Product Size



Ambalajlı Ölçüleri  
Packed Size



1 Adet m<sup>3</sup>  
1 Pcs. m<sup>3</sup>

8699897398059

1902-F

2+2

a  
495b  
435c  
470a  
165b  
410c  
505

0,03

8699897398066

1903-F

3+3

645

465

710

165

430

785

0,05

8699897398073

1904-F

4+4

505

790

925

165

450

870

0,06

8699897398080

1905-F

5+5

545

935

1145

165

470

1164

0,09

8699897398097

1906-F

6+6

575

1095

1360

165

495

1400

0,11

8699897398103

1907-F

7+7

605

1255

1575

165

616

1720

0,14

8699897398110

1908-F

8+8

635

1385

1765

165

633

1890

0,16



**ÖZEL  
ÜRETİM  
CUSTOM  
PRODUCTION**

 **Saraylı**

tam düşündüğünüz gibi | just as you thought

Firmanızın ihtiyaçları doğrultusundan çok amaçlı montaj merdivenleri istediğiniz ölçülere göre projelendirilip 3D modelleri ve teknik resimleri hazırlanarak imalata geçilmektedir.

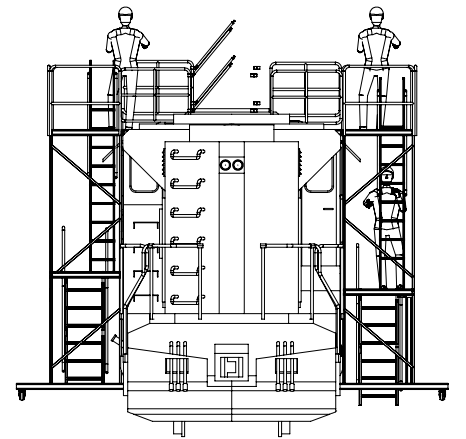
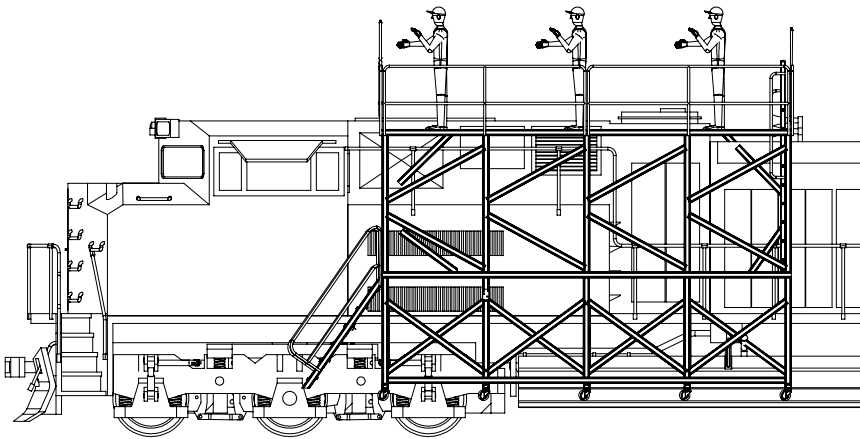



In accordance with your needs, multi-purpose montage ladders are produced by designing sizes you demand and preparing 3D models and technical images.

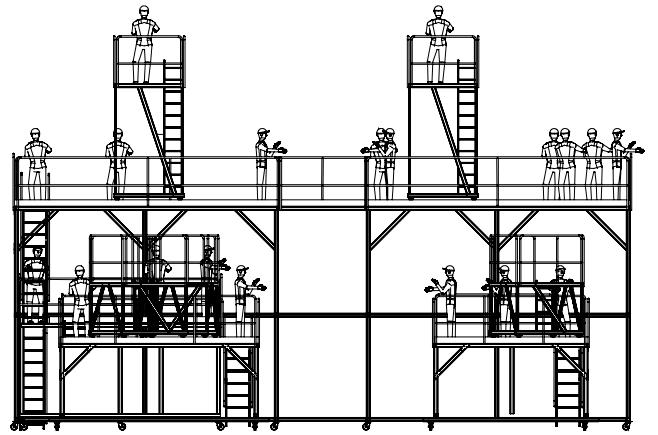
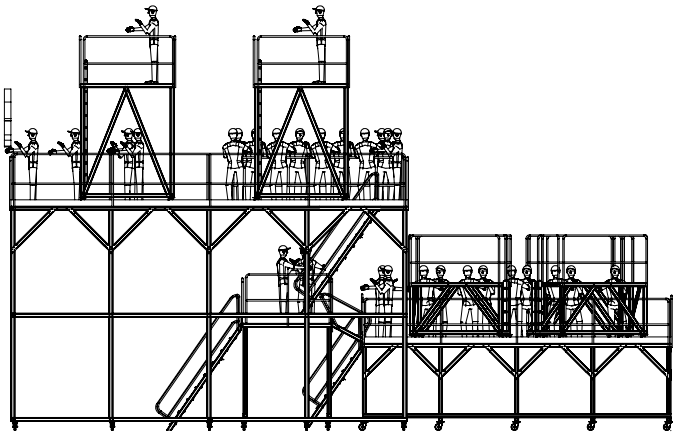

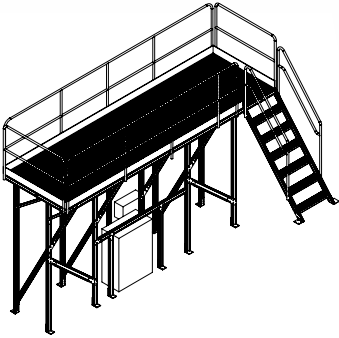
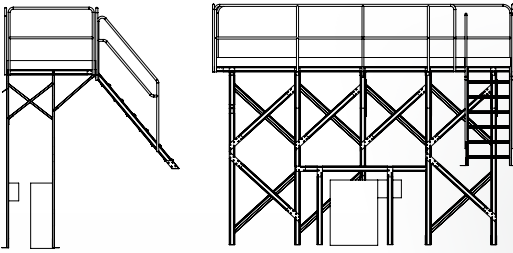
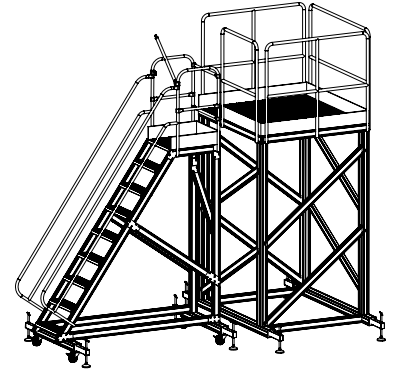
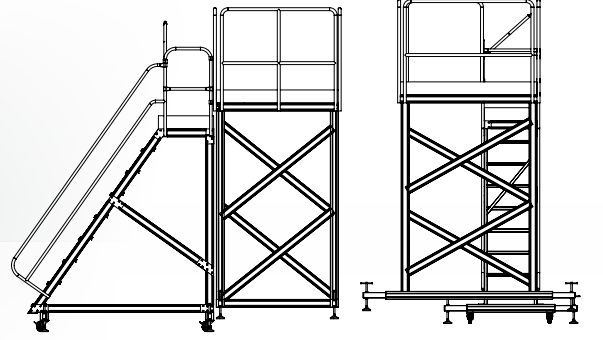

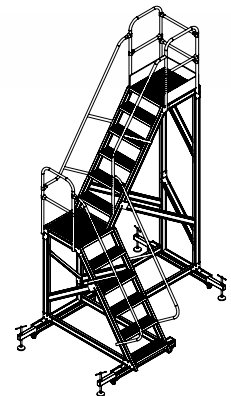
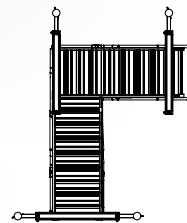
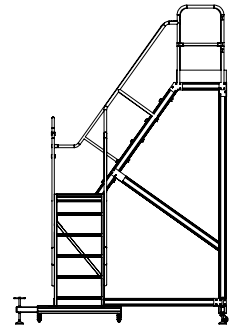
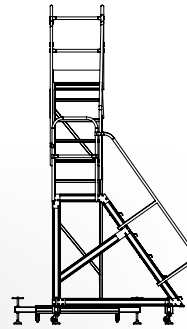
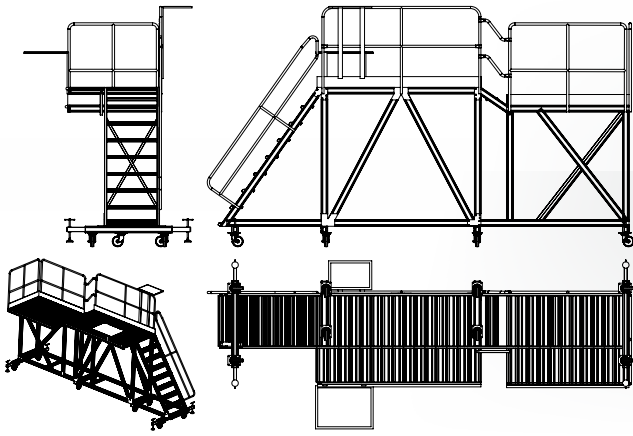

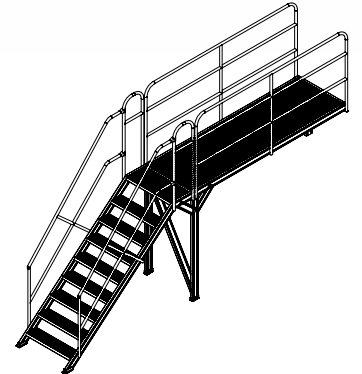
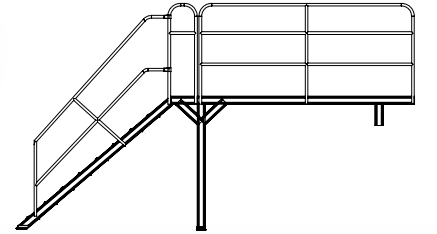
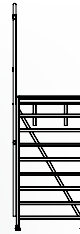
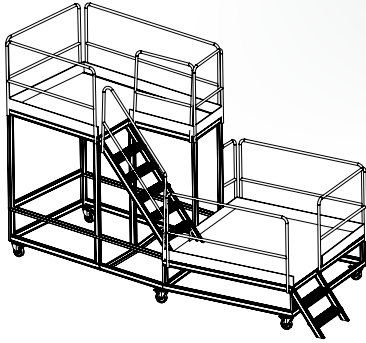
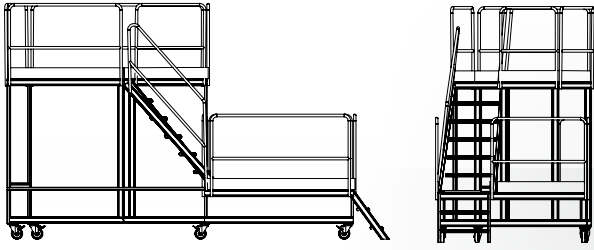



# Bizi TAKİP EDİN

FOLLOW US



/saraylimadeniesya



[www.smsarayli.com.tr](http://www.smsarayli.com.tr)



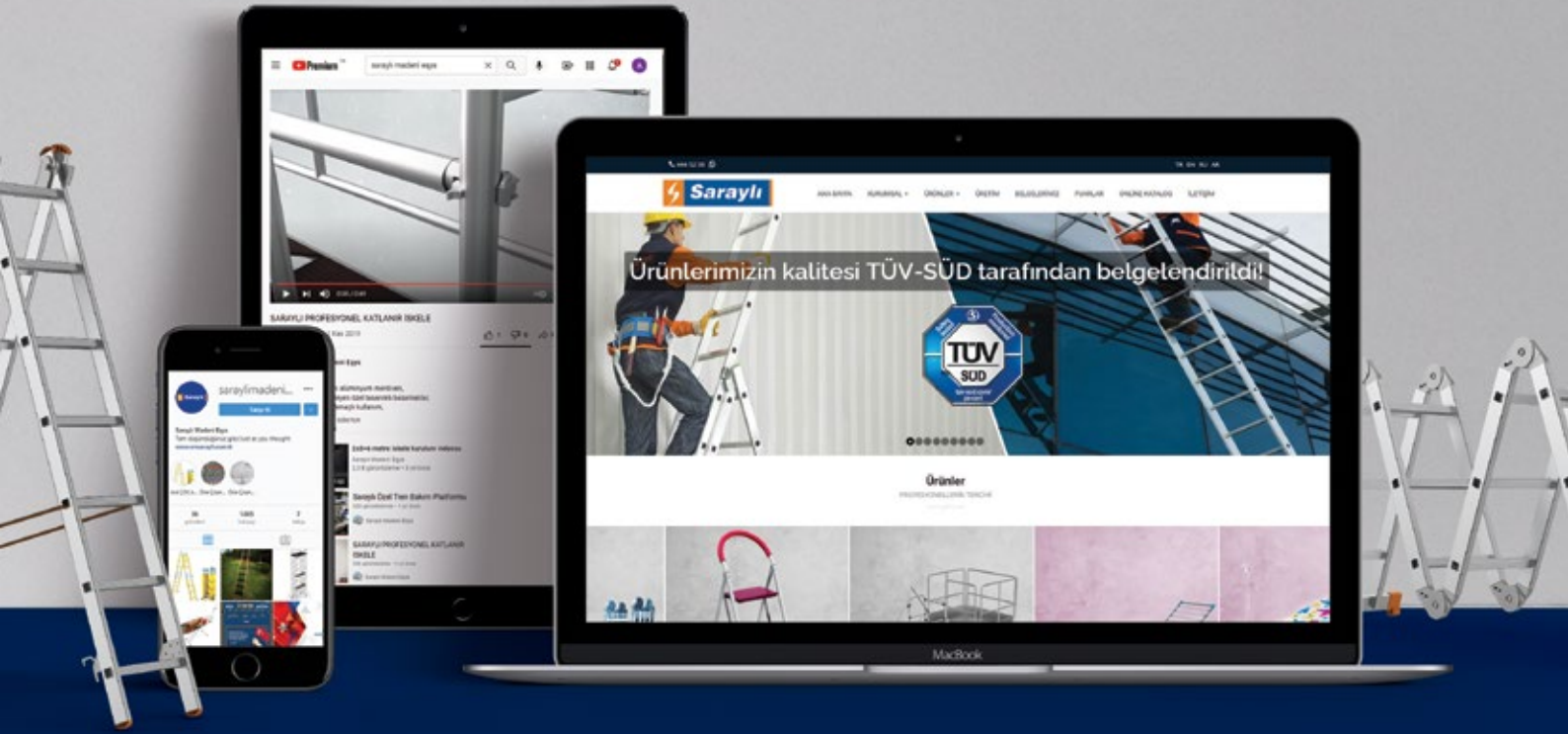

tam **düşündüğünüz** gibi *just as you thought*

ENDÜSTRİYEL MERDİVENDE  
EN ÜST BASAMAKTAYIZ

WE ARE THE TOP STEP OF THE  
INDUSTRIAL TYPE LADDER

 **Saraylı**  
tam düşündüğünüz gibi / just as you thought

Konya Organize Sanayi Bölgesi T. Ziyaeddin Akbulut Cd. No : 19 42300 Selçuklu/KONYA/TÜRKİYE  
Tel: +90 332 239 08 78 • Fax: +90 332 239 02 36 // info@smsarayli.com.tr • bilgi@smsarayli.com.tr

 **444 52 39**  
www.smsarayli.com.tr

medyakim.com